



Battery Installation and Inverter Commission Guide

For homeowners

Sep. 6th, 2022

V1.3

Contents

1 Battery Connection.....	1
1.1 Battery Communication.....	1
1.2 Power Cables Connection.....	1
2 Inverter Connection and Program	3
2.1 Closed loop communication	4
2.1.1 Sol-Ark	4
2.1.2 Phocos.....	8
2.1.3 Victron.....	10
2.1.4 Solis	14
2.1.5 Growatt	20
2.1.6 Megarevo.....	24
2.1.7 Luxpower	29
2.2 Open loop communication	33
2.2.1 Schneider.....	33
2.2.2 Outback	35
2.2.3 Magnum.....	37
Changelog Notes	40

1 Battery Connection

This manual will help connect the batteries and commission them as they related to inverters.

1.1 Battery Communication

Install the battery to battery internal communication cables.

Figure 1.1 depicts that four E-BOX batteries communicate in cascade mode. After connecting Link 0 and Link 1 Ports, one empty Ethernet port remains on each side of the battery bank. The battery whose Link 0 is empty will be the master.

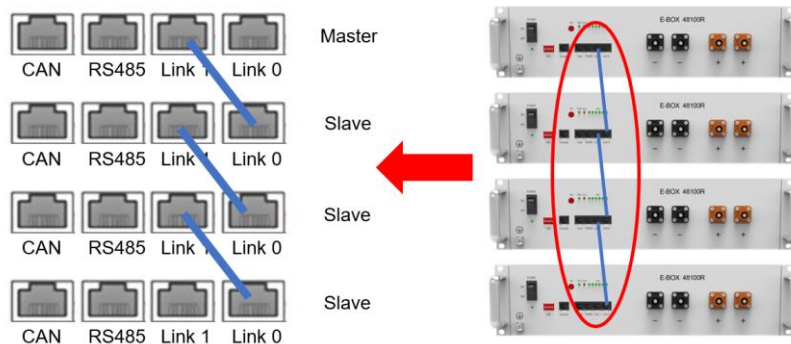

Figure 1.1 Four batteries cascade mode

Note: Pytes E-BOX series can support up to **8 units** in parallel. When more than 8 units are installed in a whole system, a HUB is a must to manage the communication. Please refer to the [HUB setting guide](#) if you want to install more than 8 batteries together.

1.2 Power Cables Connection

Pytes E-BOX Batteries are paralleled by wiring from individual E-BOX Batteries to DC busbars. Although lead acid batteries are typically wired using battery-to-battery interconnecting cables, Pytes asks that E-BOX Batteries NOT be wired in this way.

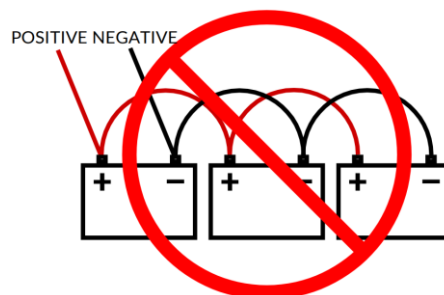

Figure 1.2 Incorrect E-BOX Batteries wiring

Figure 1.3 depicts four E-BOX Batteries wired in Parallel. This configuration requires 8 identical lengths of 4# gauge copper wire.

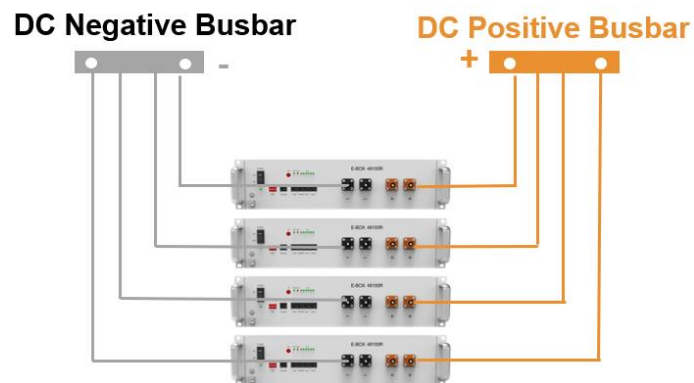

Figure 1.3 Four E-BOX Batteries in Parallel

Helpful Tips:

- Each Pytes E-BOX Battery's individual wire runs are typically sized at 4 AWG.
- Battery cables can be custom ordered to include the 3/8" lugs and Amphenol connectors which models are 10-730186/10-730188.
- Click to this link to secure more information about Busbar or Combiner.
- Pytes custom Y shaped cable is available for every two batteries connection. Figure 1.4 depicts two batteries wired together by this cable.



Figure 1.4 Pytes custom Y shaped cable

2 Inverter Connection and Program

Custom ethernet cable and DIP Switch Setting

Figure 2.1 depicts Pytes E-BOX battery's pin assignment. Since different brand inverter has different pin assignment, a custom ethernet cable may be necessary for the communication. Please refer to Appendix for the specific details.

Note that it matters which side of the cable is plugged into the battery and inverter respectively (follow the labels on the cable itself if using the included factory cable).

Figure 2.1 Pytes E-BOX battery Pin assignment

Pin	1	2	3	4	5	6	7	8
Function	RS-485B	RS-485A		CAN-H	CAN-L		RS-485A	RS-485B

*The legacy product pin assignment is pin 1&3 for RS485B&A, pin 3&4 for CAN-H&L.

Set the DIP Switch according to the paired inverter brand. Note that only every master battery needs to set the DIP Switch.

Power cables connection

Connect the Positive and Negative power cables to the inverter. Note that ensure the battery "ON/OFF" switch is in the "OFF" position during the wiring.

Connect the power cables between inverter and battery or the Busbars as shown in Figure 2.2.

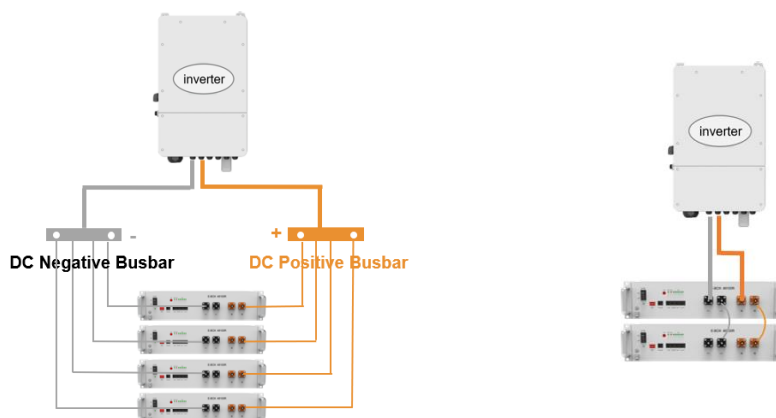

Figure 2.2 Inverter Power Cables Connection

Please refer the inverter manual for the proper cable gauge that connect the busbar or the inverter.

2.1 Closed loop communication



Connect the cables and set the DIP switch

Connect the power cables between inverter and battery or the Busbars as mentioned before. See the Figure 2.1.1.1 to check the position of Sol-Ark Battery Connectors.

As for the cable gauge that connects the busbar to the inverter, 4/0 gauge power cable is commended for Sol-Ark 15K model and 3/0 gauge power cable is commended for 8K/12K model.

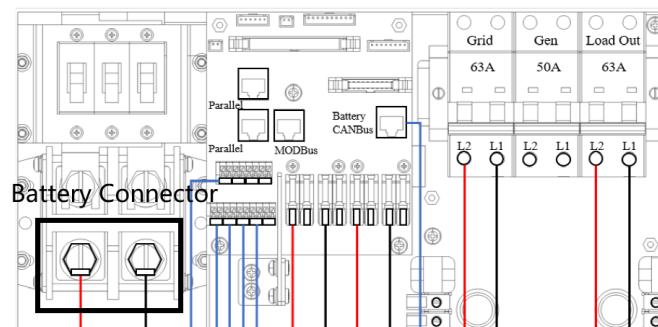

Figure 2.1.1.1 Sol-Ark Battery Connectors

A standard ethernet cable can be used for the communication since Sol-Ark inverter pin assignment is the same as Pytes E-BOX battery.

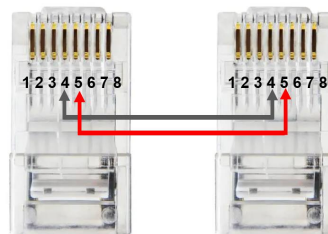

Figure 2.1.1.2 Sol-Ark Custome ethernet cable

Plug in the battery end into the **CAN port** of the Pytes E-BOX battery and plug in the

inverter end into Sol-Ark Battery **CANBus** Port as shown in the Figure 2.1.1.3.

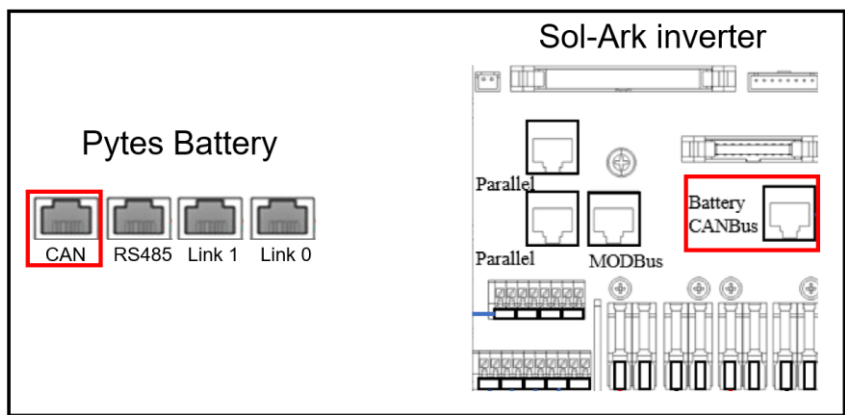

Figure 2.1.1.3 Sol-Ark inverter comm cable connection

Set the DIP Switch of **every master battery** as Figure 2.1.1.4 shown.

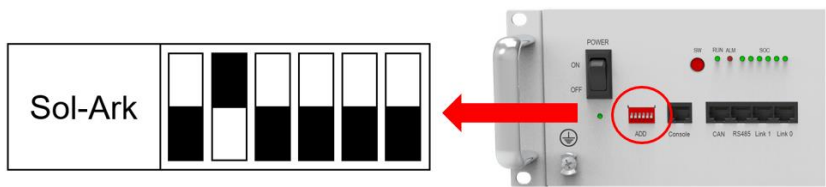

Figure 2.1.1.4 Sol-Ark inverter DIP Switch Setting

Program the inverter

Press the gear icon on the top right of the screen and then press battery set up menu.

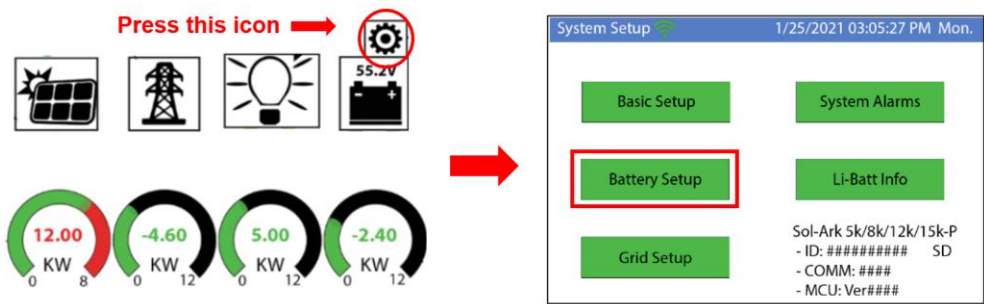

Figure 2.1.1.5 Sol-Ark Batt Setup

Set the battery parameters

- Batt Capacity: 100Ah per unit
- Max A Charge/Discharge: 185A is the max amps that Sol-Ark 8K/12K mode supports and the corresponding number is 275A for 15K mode. Fill in the max amps or (50A*unit numbers) which is lower. (For example, there are three Pytes E-BOX batteries and

one 12K Sol-Ark inverter in a system. The max amps of 12K is 185A and three batteries can support 150A(50*3). So the number should fill in is 150A.)

- Select “Use Batt% Charged”.
- Enable “BMS Lithium Batt” and set its value to “00”.
- Turn on “Activate Battery”.

Note that enabling BMS Lithium Batt 00 will adjust some values and make other values unadjustable (like the temperature coefficient above). Just ignore those values - the BMS is in control.

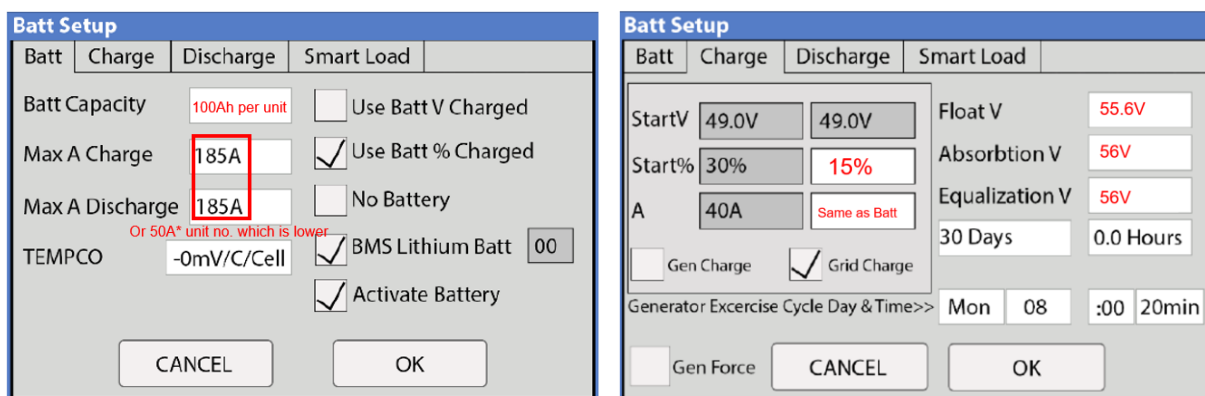

Figure 2.1.1.6 Batt Setup

Program the Charge tab in Batt Setup

See the right picture in Figure 2.1.1.6.

- Start%: 15%
- A: Same as the Max A Charge in Batt Setting
- Float V: 55.6V
- Absorption V: 56V
- Equalization V: 56V

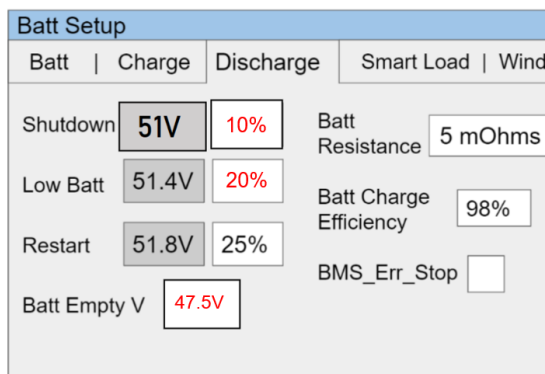

Figure 2.1.1.7 Batt Discharge Setup

Program the Discharge tab in Batt Setup

- Shutdown: 10%
- Low Batt: 20%
- Batt Empty: 47.5V

Confirm Inverter-Battery Communication

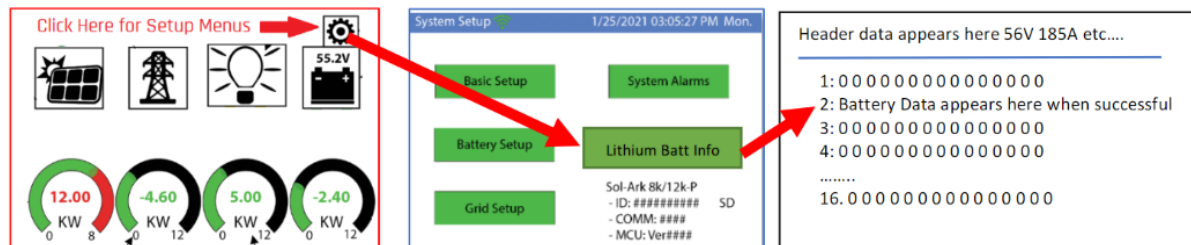

Figure 2.1.1.8 communication confirm

Please refer to the [Sol-Ark inverter manual](#) for more setting such as Grid Setup, PV Setting, Time-of-Use, etc.



Connect the cables and set the DIP Switch

Connect the power cables between inverter and battery or the Busbars as mentioned in Section 2 inverter connection.

A custom ethernet cable is needed for the communication between Pytes E-BOX battery and Phocos Any-Grid™ series.

Figure 2.1.2.1 Pin assignment of Phocos Any-Grid™ series inverter

Pin	1	2	3	4	5	6	7	8
Function			RS-485B		RS-485A			

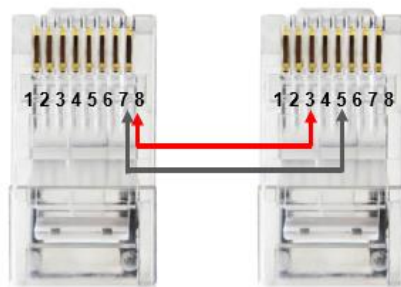

Figure 2.1.2.2 Phocos ethernet cable

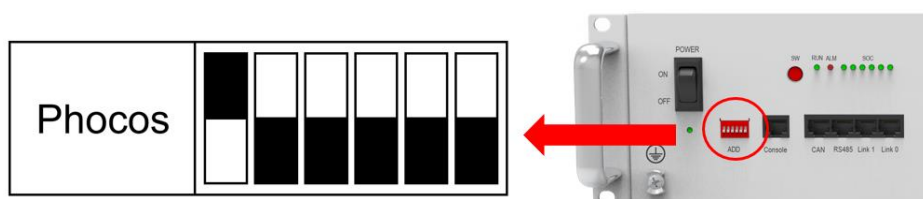

Figure 2.1.2.3 Phocos DIP switch setting

Plug in the battery end into the **RS485 port** of the Pytes E-BOX battery and plug in the inverter end into Phocos **BMS Port** as shown in the Figure 2.1.2.4

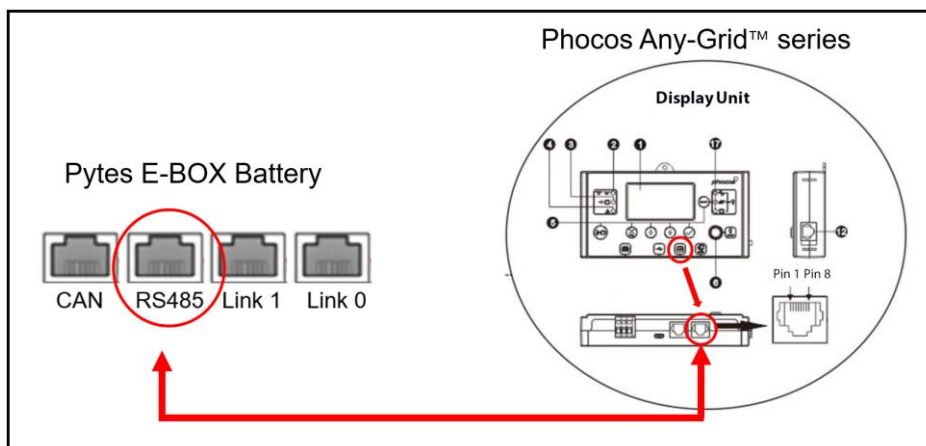





Figure 2.1.2.4 Phocos inverter comm cable connection

Program the inverter

Press  for 3 seconds to enter settings mode.

Press  or  to select between settings menus. Once selected, press  to confirm the selection or to exit without confirmation.

Select 05 (Battery type) and set the value to  (RS-485) as shown in Figure 2.1.2.5.



Figure 2.1.2.5 Phocos inverter battery type selection

Please refer to the [Phocos AnyGrid Hybrid inverter manual](#) for more setting such as Grid Setup, PV Setting, etc.



Connect the communication cable

A custom ethernet cable is needed for the communication between Pytes E-BOX battery and Color Control GX.

Figure 2.1.3.1 Pin assignment of Victron MultiPlus-II (or Quattro-II) series inverter.

Pin	1	2	3	4	5	6	7	8
Function							CAN-H	CAN-L

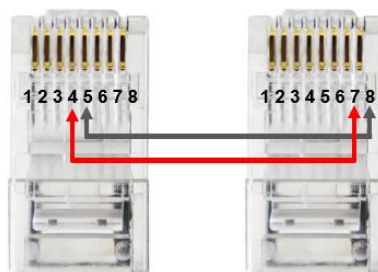

Figure 2.1.3.2 Victron ethernet cable

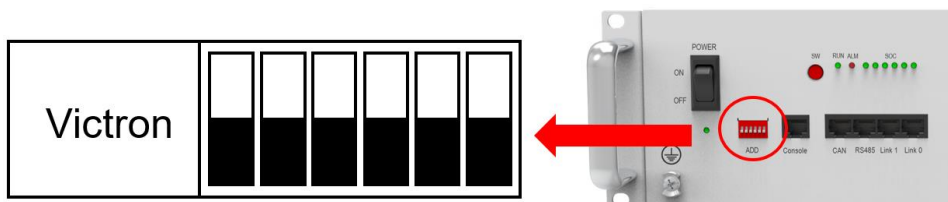

Figure 2.1.3.3 Victron DIP Switch Setting

Connect the **VE.Bus** ends of the inverter and Color Control GX by standard ethernet cable. Plug in the battery end into the **CAN** of the Pytes E-BOX battery and plug in the inverter end into the **VE.CAN** of the Color Control GX as shown in the Figure 2.1.3.4.

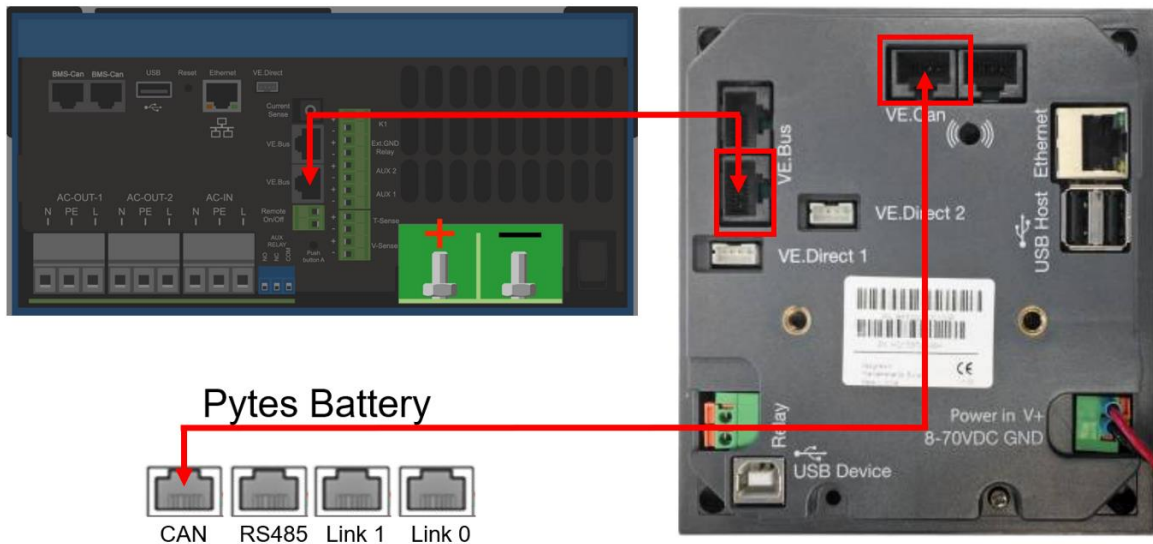

Figure 2.1.3.4 Communication cable connection

If you bought any other products of Victron Energy, please refer to the Figure 2.1.3.5 below or Manual to connect it.

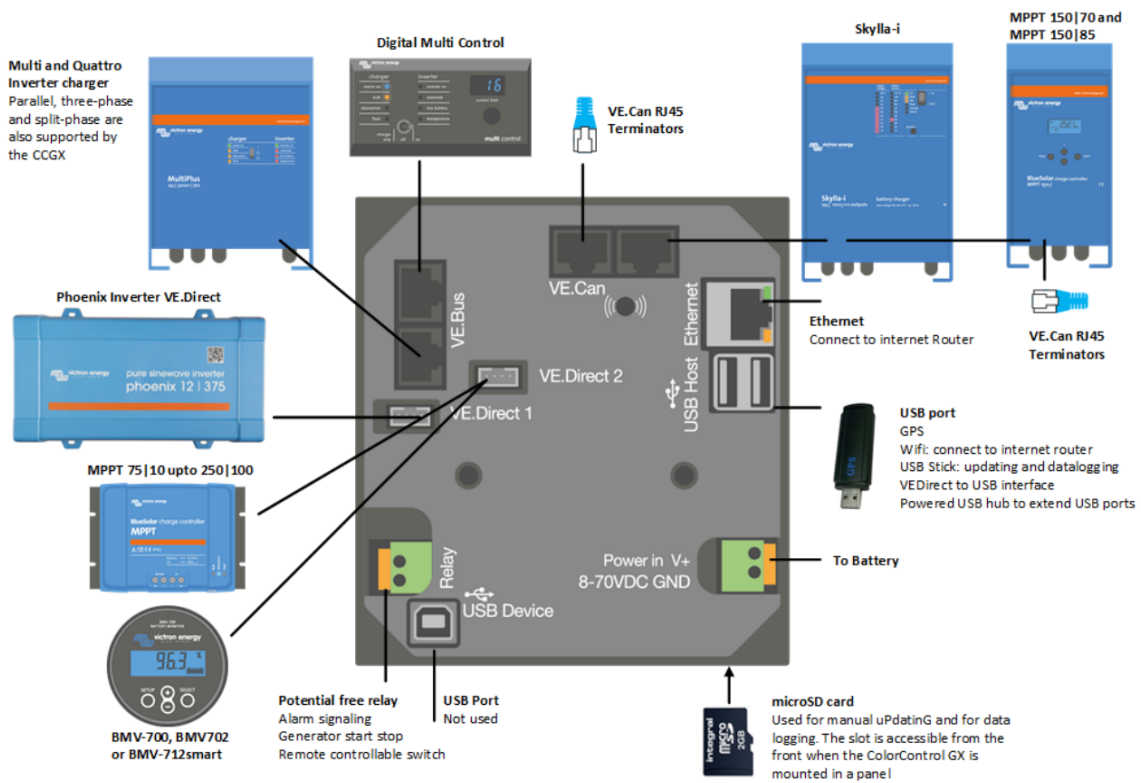

Figure 2.1.3.5 Victron Devices Connection

Program the inverter

Press the switch on the inverter to enter settings mode.

As shown in Figure 2.1.3.7, press “up” or “down” button to select between settings menu.

Press “left” or “right” button to “return” or “enter”.



Figure 2.1.3.6 Victron Inverter Switch



Figure 2.1.3.7 Victron Color Control

As shown in the Figure 2.1.3.8, follow below steps to set the boud rate.

- Press Settings and down to the Services at the bottom line.
- Select the VE.CAN port line.
- Select the CAN-bus BMS (500 Kbit/s).

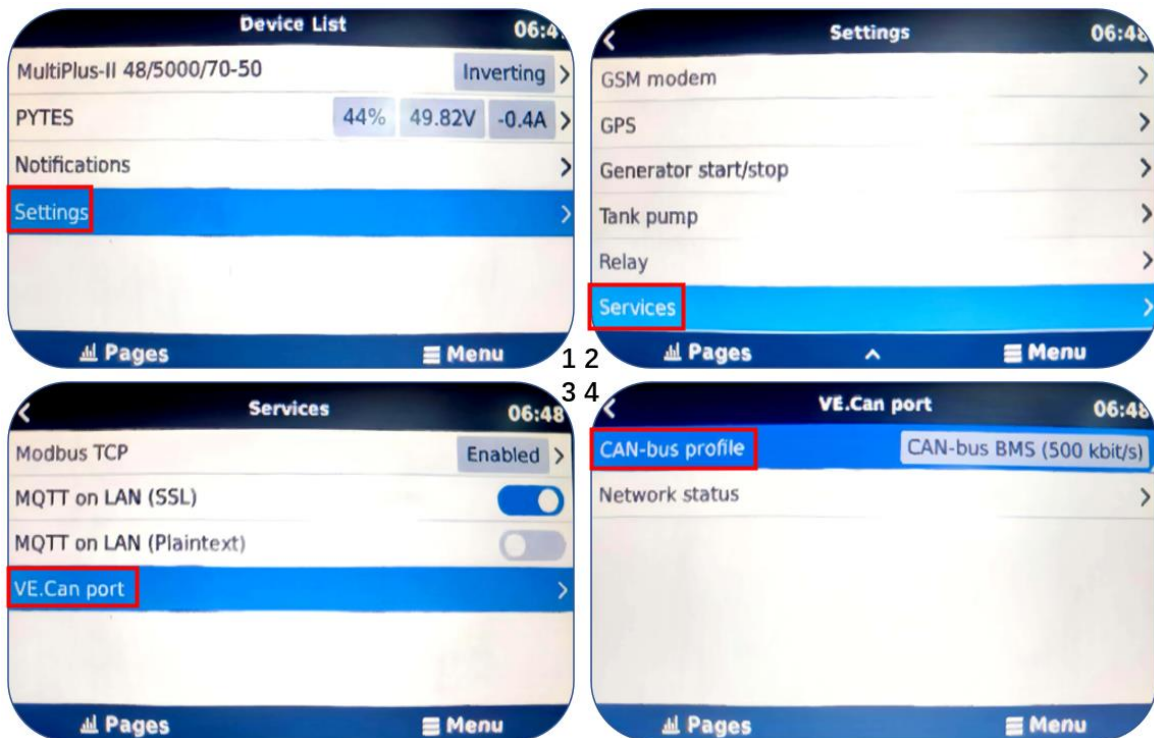

Figure 2.1.3.8 CAN-Port Setting

Check device connection information shown in the Figure 2.1.3.8.

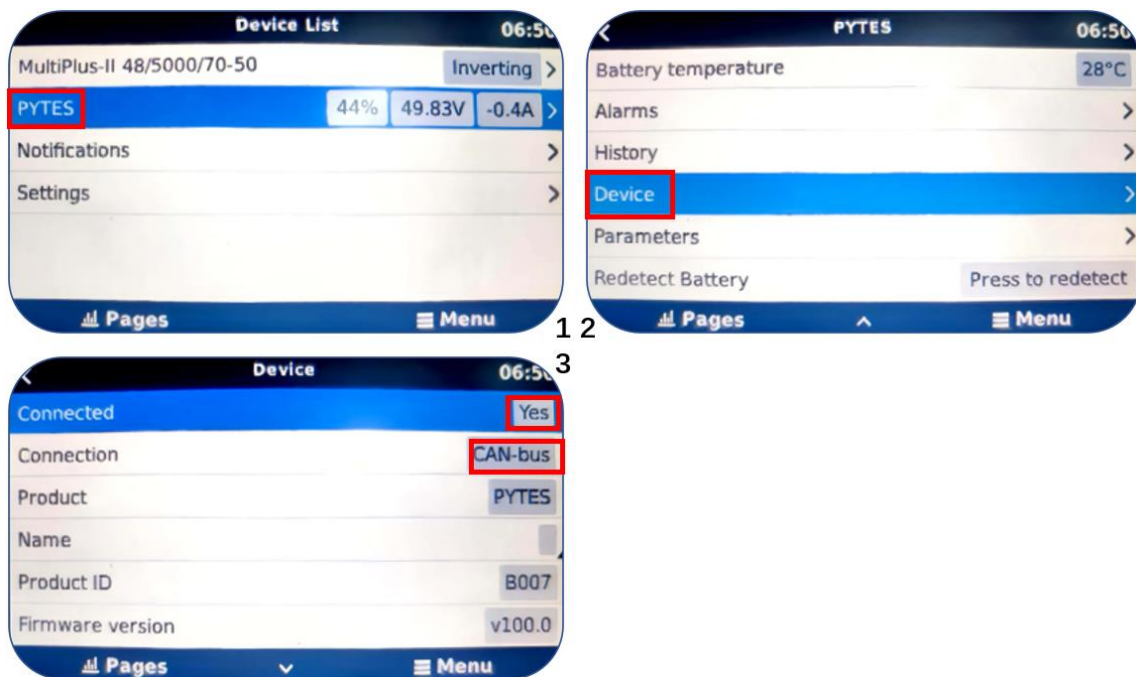

Figure 2.1.3.9 Device connection information

Check out the battery parameters.

- Check the battery basic parameters: SOC, Voltage and Current on the PYTES line as shown in Figure 2.1.3.10(1).
- Go into PYTES, check more battery details, as shown in Figure 2.1.3.10(2) & (3).

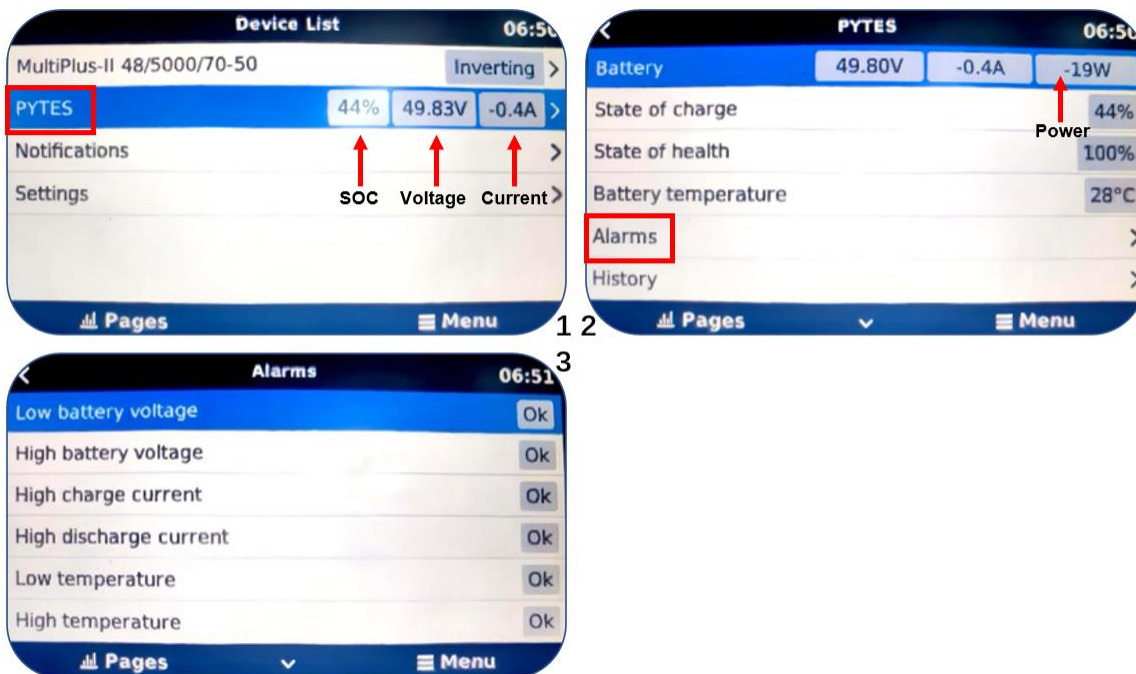

Figure 2.1.3.10 Device connection information

Please refer to the [Victron Energy Inverter](#) for more settings.

2.1.4 solis



Connect the communication cable

A standard ethernet cable is okay for the communication between Pytes E-BOX battery and Solis RHI 48ES Series inverter.

Figure 2.1.4.1 Pin assignment of Solis inverter

Pin	1	2	3	4	5	6	7	8
Function				CAN-H	CAN-L			

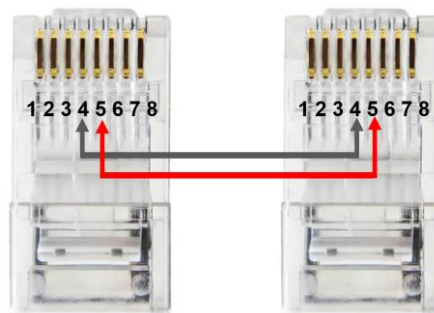

Figure 2.1.4.2 Solis DIP Switch Setting

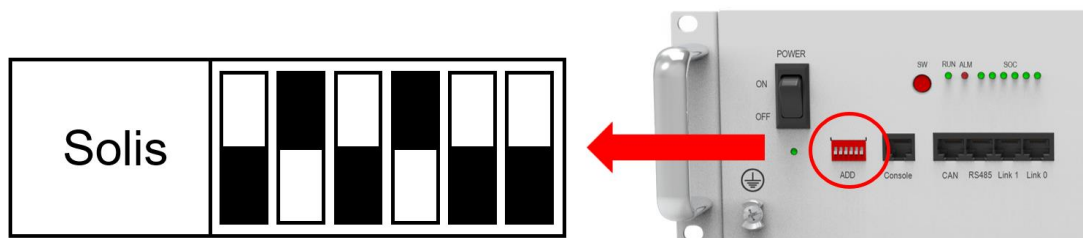

Figure 2.1.4.3 Solis DIP Switch Setting

Plug in the battery end into the **CAN port** of the Pytes E-BOX battery and plug in the inverter end into **BMS Port** of Solis RHI 48ES Series inverter as shown in the Figure 2.1.4.3.

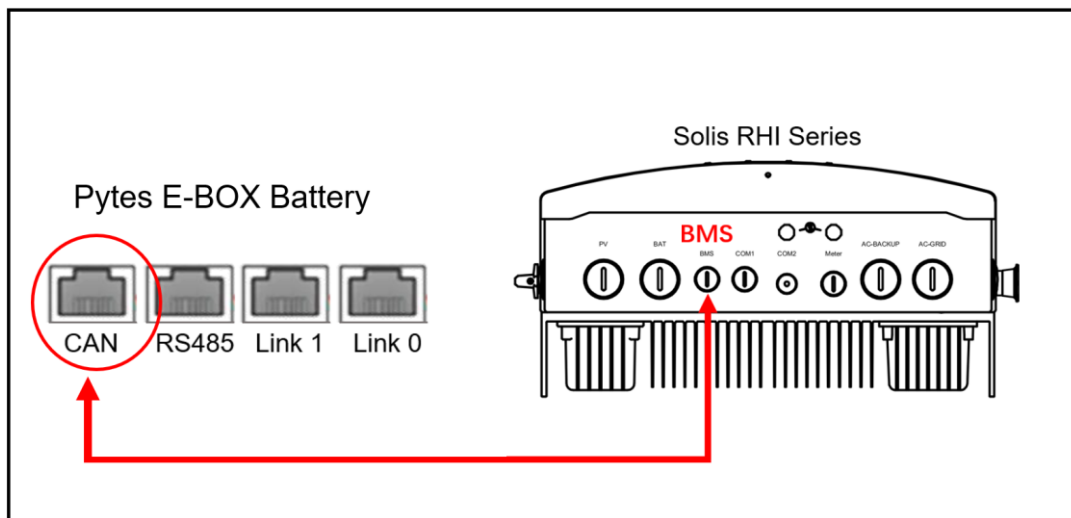

Figure 2.1.4.4 Solis inverter comm cable connection

Program the inverter

There are four keys in the front panel of the inverter (from left to right): ESC, UP, DOWN and ENTER keys. The keypad is used for:

- 1) Scrolling through the displayed options (the UP and DOWN keys);
- 2) Access and modify the settings (the ESC and ENTER keys).



Figure 2.1.4.5 Keypad of Solis inverter

When powering up the inverter for the first time, it is required to set the language. Press "ENT" to select.

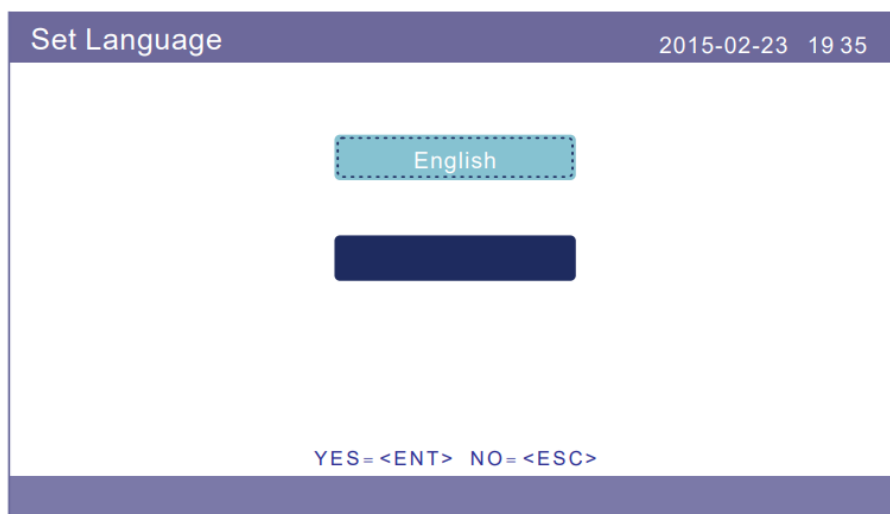

Figure 2.1.4.6 Set Language

After setting the language, press "ESC" to access the main page.

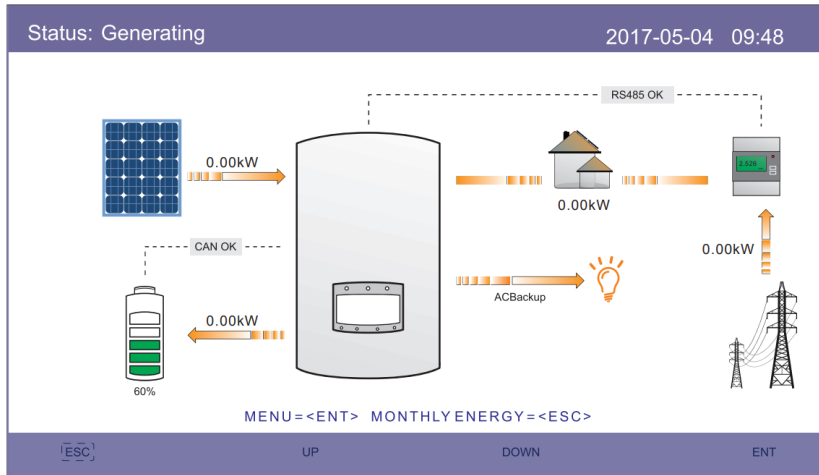

Figure 2.1.4.7 Main Page

Press "ENT" to access the main menu.

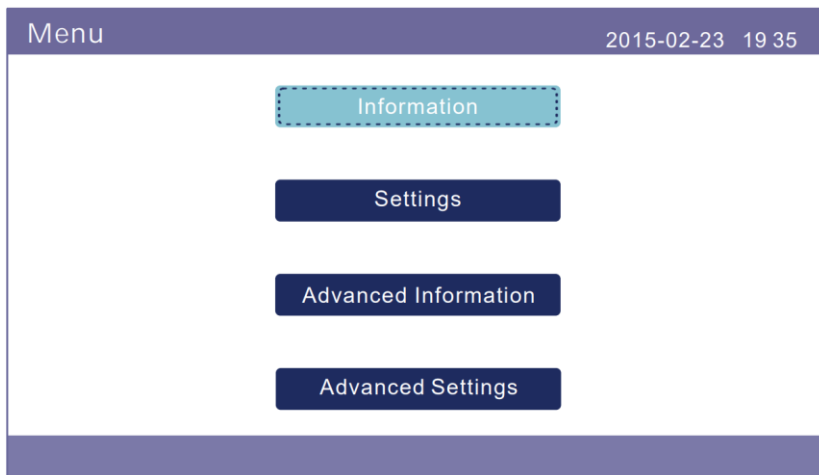

Figure 2.1.4.8 Main Menu

Press "Advanced Settings" and input password "0010" to enter advanced settings interface.

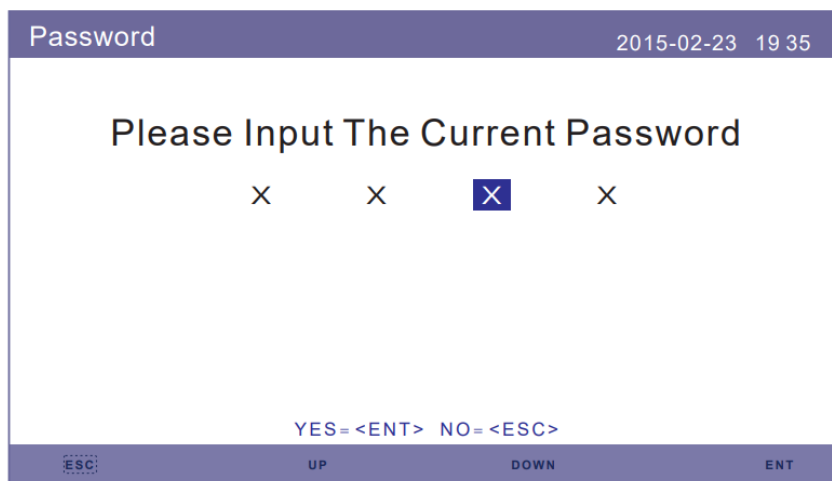
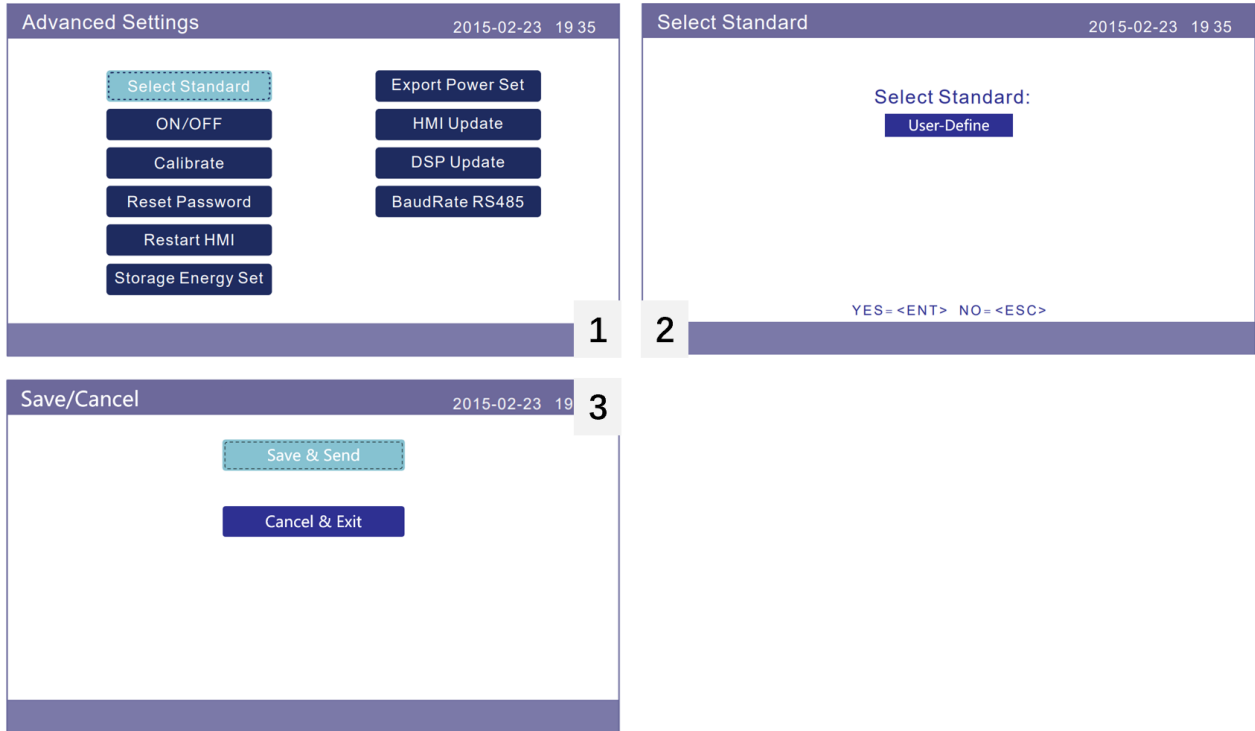
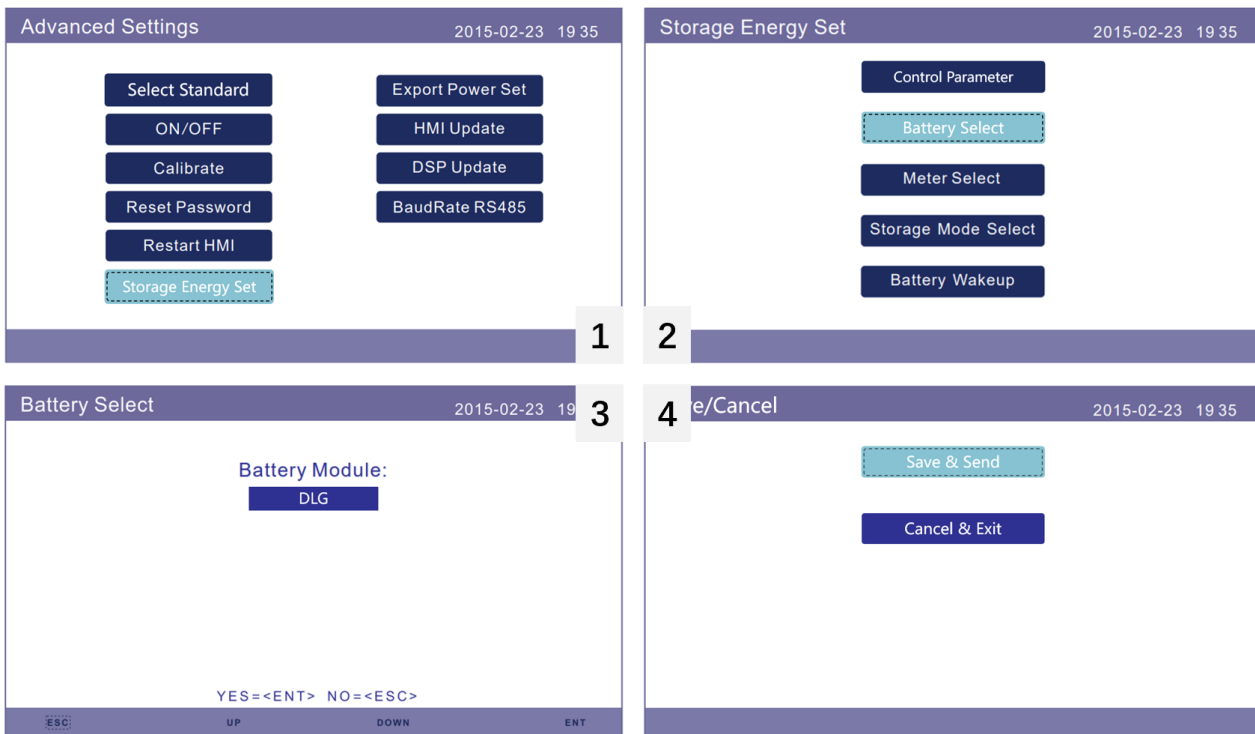

Figure 2.1.4.9 Enter Password

STEP 1 “Select Standard” → “User Define” → “Save & Send”.



Step 2 “Storage Energy Set” → “Battery Select” → “DLG” → “Save & Send”. (DLG is the former name of Pytes.)



Step 3 “Storage Energy Set” → “Storage Mode Select” → “Off grid” → “ON” → “Time of use” → “Run” → “Save & Send”.



Step 4 “Storage Energy Set” → “Storage Mode Select” → “Off grid” → “OFF”.

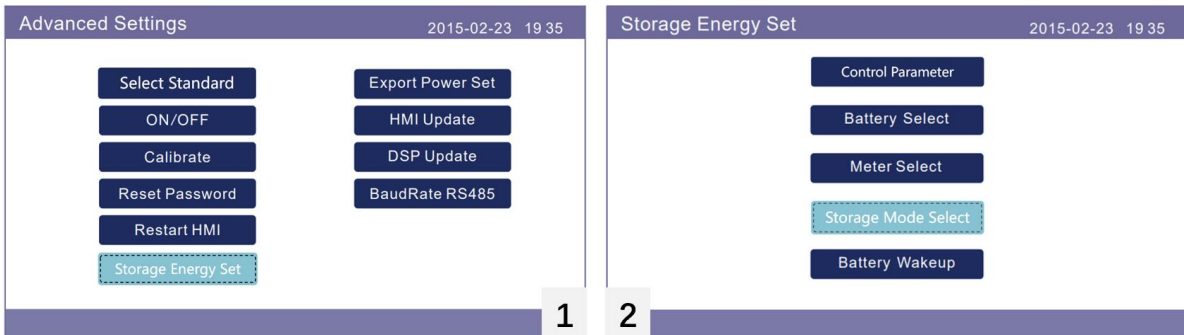

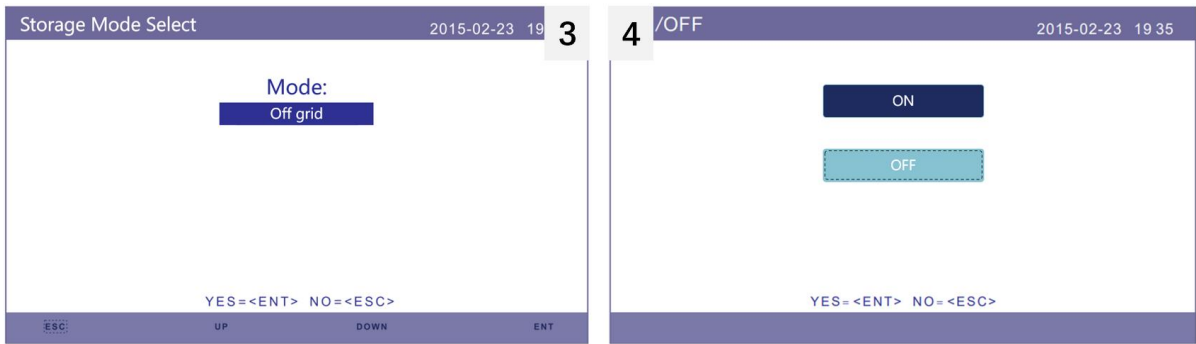

Step 5 “Export Power Set” → “ON/OFF” → “OFF”.

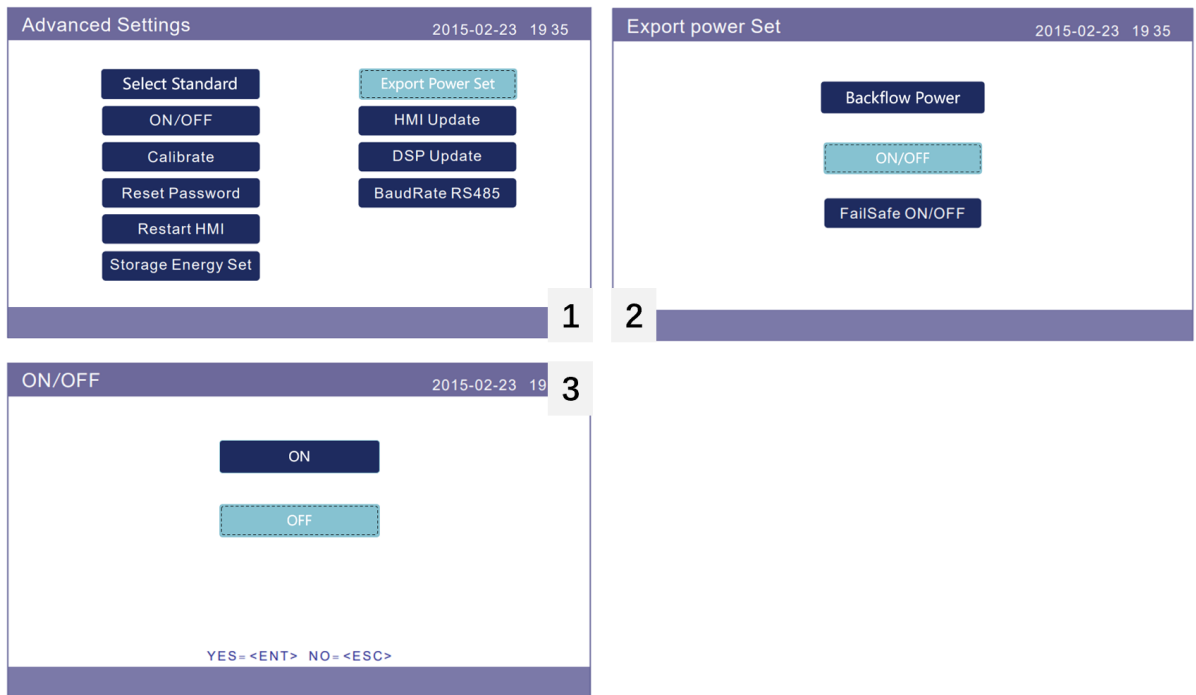

***CAUTION:** If you want more details about system monitoring, please check the operating manual of inverters.



Connect the cables and set the DIP Switch

Connect the power cables between inverter and battery or the Busbars as mentioned in Section 2 inverter connection. See the Figure 2.1.5.1 to check the position of Growatt Battery Connectors.

A standard ethernet cable can be used for the communication since Growatt inverter pin assignment is the same as Pytes E-BOX battery.

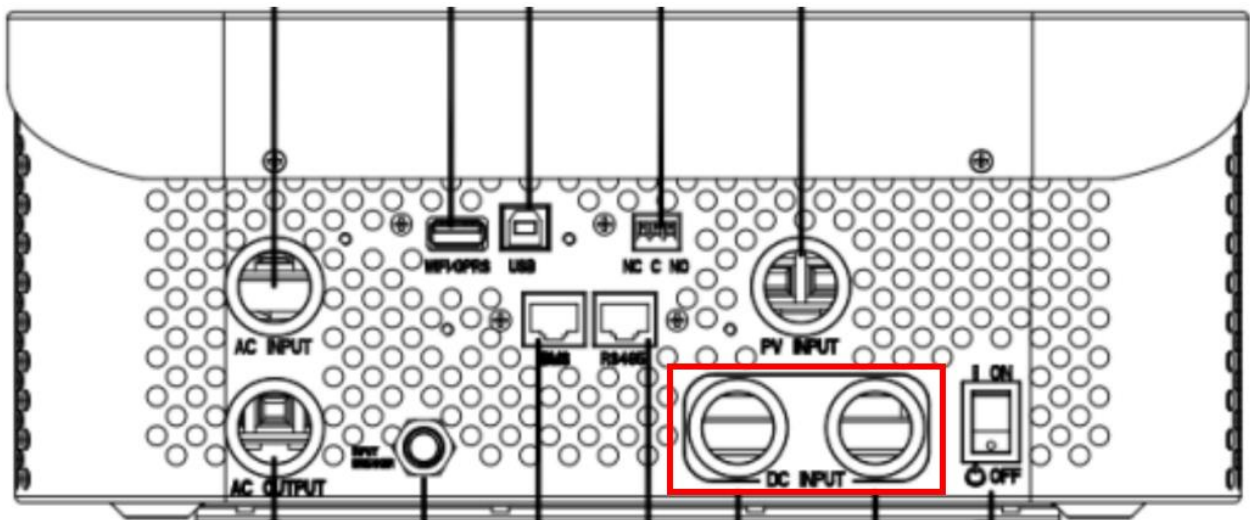

Figure 2.1.5.1 Growatt Battery Connectors

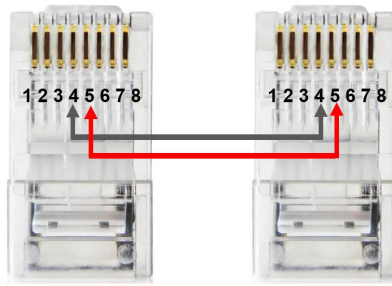

Figure 2.1.5.2 Growatt ethernet cable

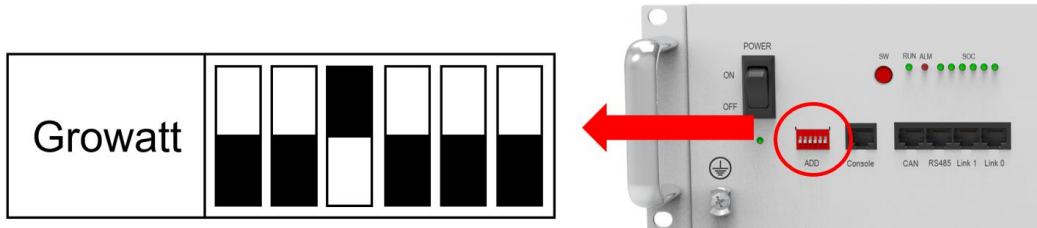

Figure 2.1.5.3 Growatt DIP switch setting

Plug in the battery end into the **CAN** port of the Pytes E-BOX battery and plug in the inverter end into Growatt **BMS Port** as shown in the Figure 2.1.5.4.

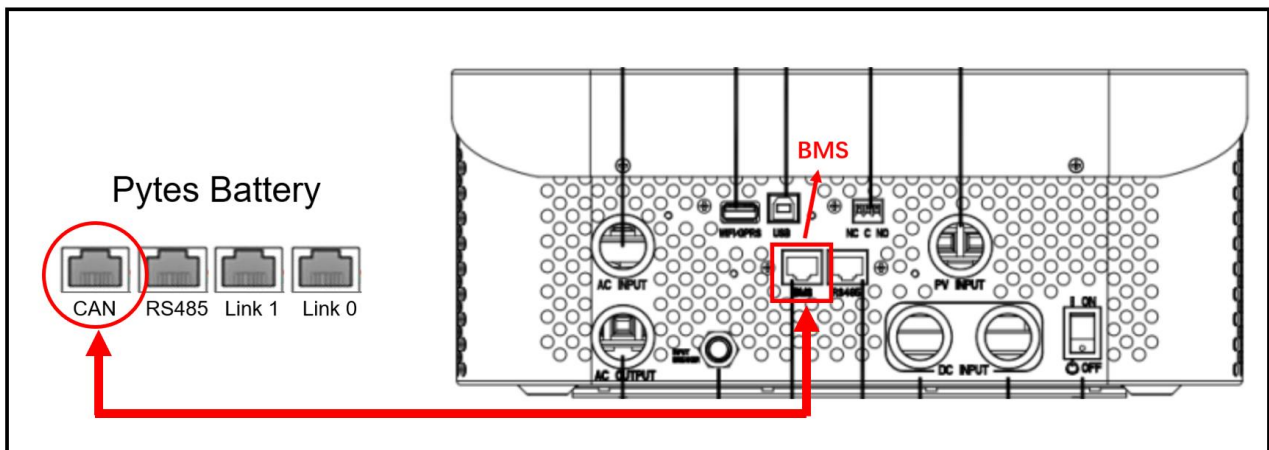

Figure 2.1.5.4 Growatt inverter comm cable connection

Program the inverter

The operation and display panel, shown in below chart, is on the front panel of the inverter. It includes three indicators, four function keys and LCD display, indicating the operating status and input/output power information. (shown in the Figure 2.1.5.5)

Esc: To exit setting mode

UP: To go to previous selection

DOWN: To go to next selection

ENTER: To confirm the selection in setting mode or enter setting mode

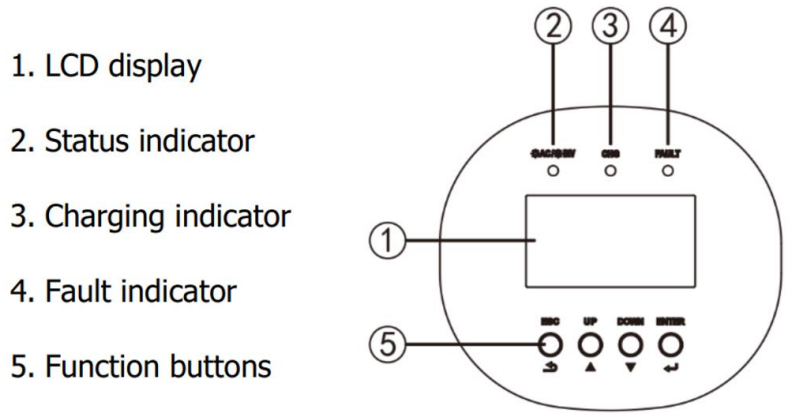

Figure 2.1.5.5 Growatt operation panel

STEP 1 After pressing and holding ENTER button for 3 seconds, it will enter setting mode. Please set the output source priority as “SBU” (SBU priority) in Program 01.



Figure 2.1.5.6 Growatt operation panel

STEP 2 Set the AC input voltage range as “APL” (Application) in Program 03.



Figure 2.1.5.7 Growatt operation panel

STEP 3 Set the power saving mode enable/disable as “SDS” (Saving mode disable) in Program 04.

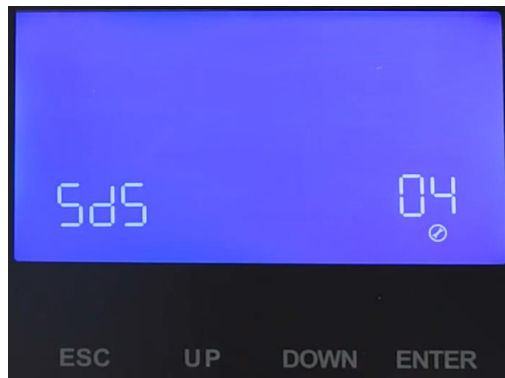

Figure 2.1.5.8 Growatt operation panel

STEP 4 Set the battery type as “LI” (Lithium) in Program 05, and it will switch to Program 36 to choose battery type. Then set “L51” (Protocol) in Program 36.



Figure 2.1.5.9 Growatt operation panel

Please refer to the [Growatt inverter manual](#) for more settings.



Connect the cables and set the DIP Switch

Connect the power cables between inverter and battery or the Busbars as mentioned in Section 2 inverter connection. See the Figure 2.1.6.1 to check the position of Megarevo Battery Connectors.

A standard ethernet cable can be used for the communication since Megarevo inverter pin assignment is the same as Pytes E-BOX battery.



Figure 2.1.6.1 Megarevo Battery Connectors

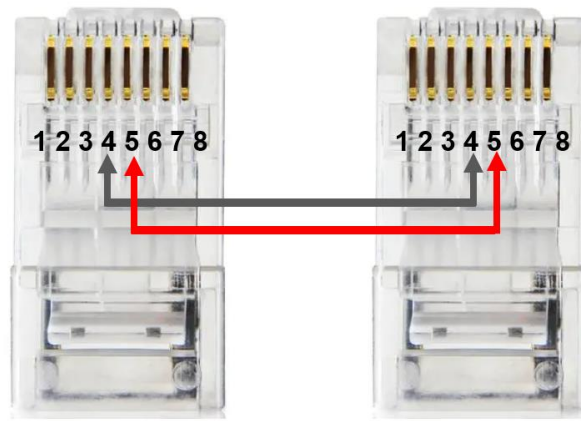

Figure 2.1.6.2 Megarevo ethernet cable

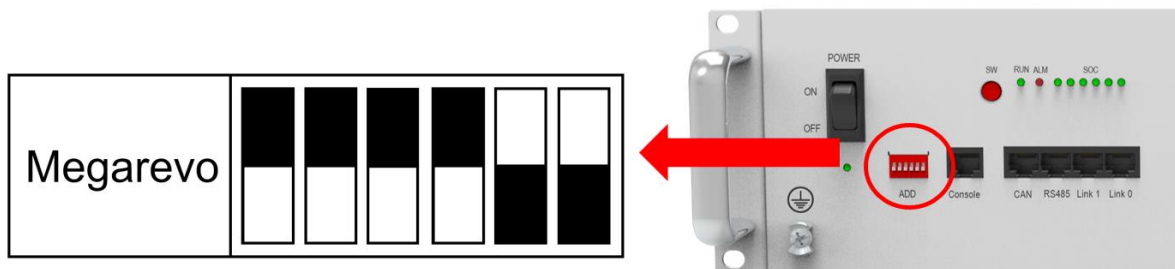

Figure 2.1.6.3 Megarevo DIP switch setting

Plug in the battery end into the **CAN port** of the Pytes E-BOX battery and plug in the inverter end into Megarevo **COM Port** as shown in the Figure 2.1.6.4.

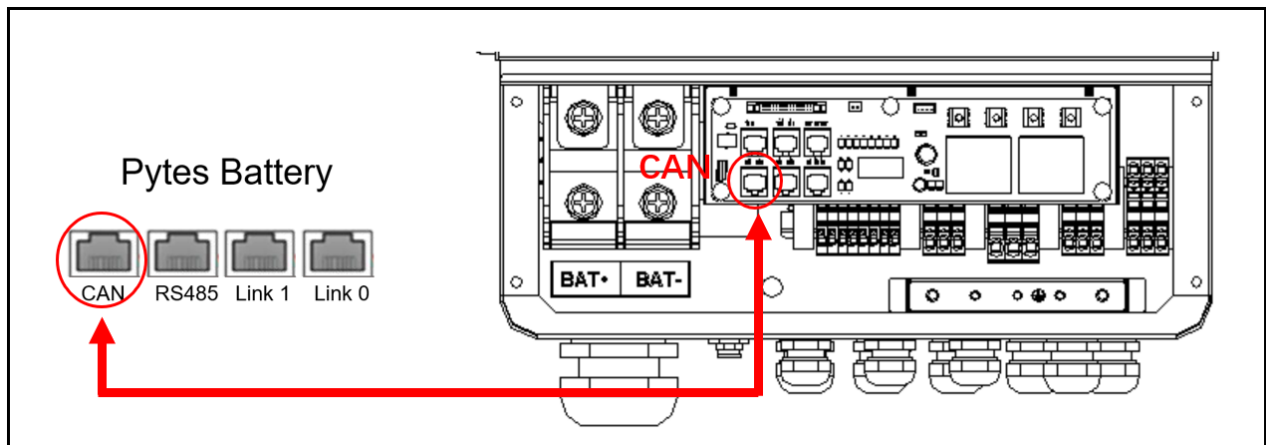

Figure 2.1.6.4 Megarevo inverter comm cable connection

Program the inverter

The operation and display panel, shown in below chart, is on the front panel of the inverter. It includes four indicators, four function keys and LCD display, indicating the operating status and input/output power information. (shown in the Figure 2.1.6.5)

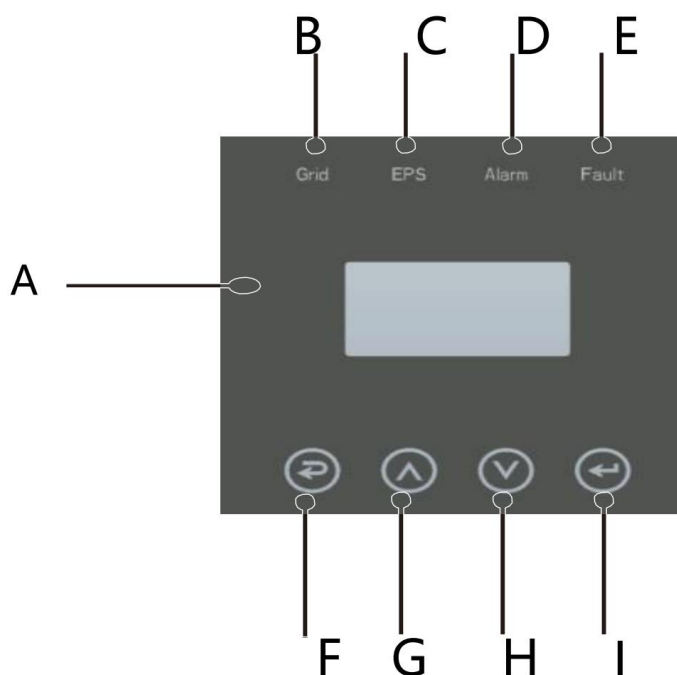

Figure 2.1.6.5 Megarevo operation panel

Object	Name	Description
A	LCD	Display the information of the inverter.
B	Indicator LED	lit in green: The inverter is in grid mode. Off: The inverter is in not in grid mode.
C		lit in green: The inverter is in off-grid mode. Off: The inverter is in not in off-grid mode.
D		lit in Yellow: The inverter is in Warning . Off: The inverter has no Inverter Warning
E		lit in red: The inverter is in fault status. Off: The inverter has no errors.
F	Function Button	Esc: Return from current interface or function.
G		Up: Move cursor to upside or increase value.
H		Down: Move cursor to downside or decrease value.
I		Enter: Confirm the selection.

Figure 2.1.6.6 Megarevo operation panel description

STEP 1 Set up the mode according to the local power grid, PV input mode and battery type.

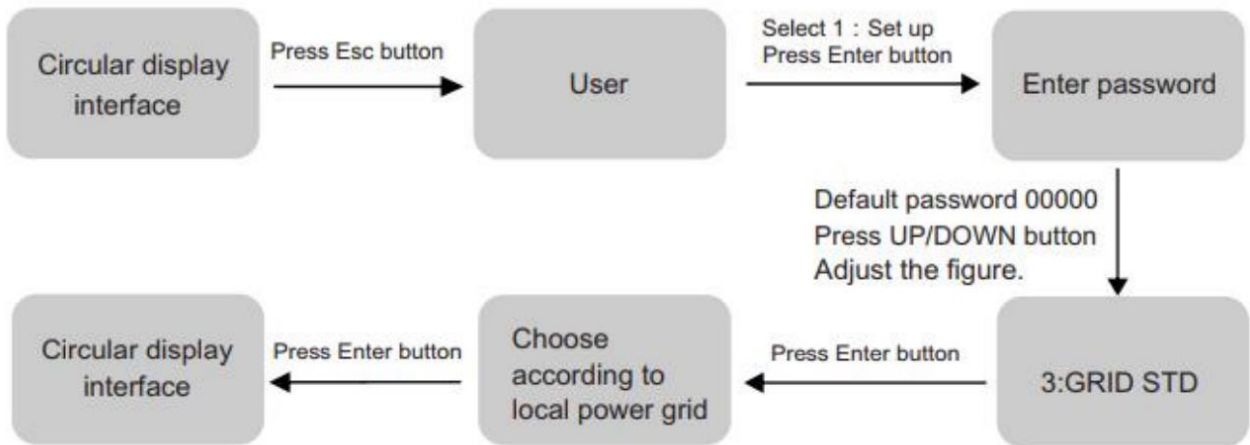

Figure 2.1.6.7 Power grid setting

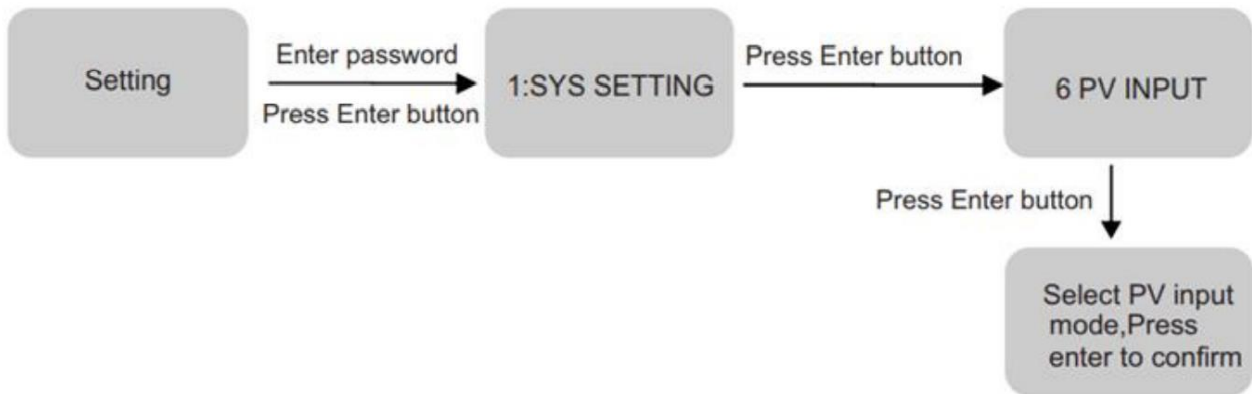

Figure 2.1.6.8 PV input setting

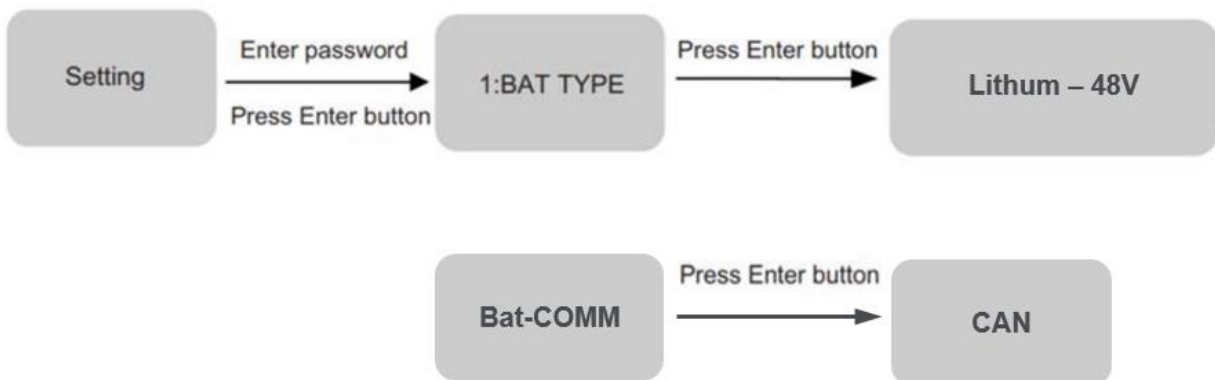

Figure 2.1.6.9 Battery parameters setting

STEP 2 More settings can be made according to the usage scenario, the setting options are shown in figure 2.1.6.10.

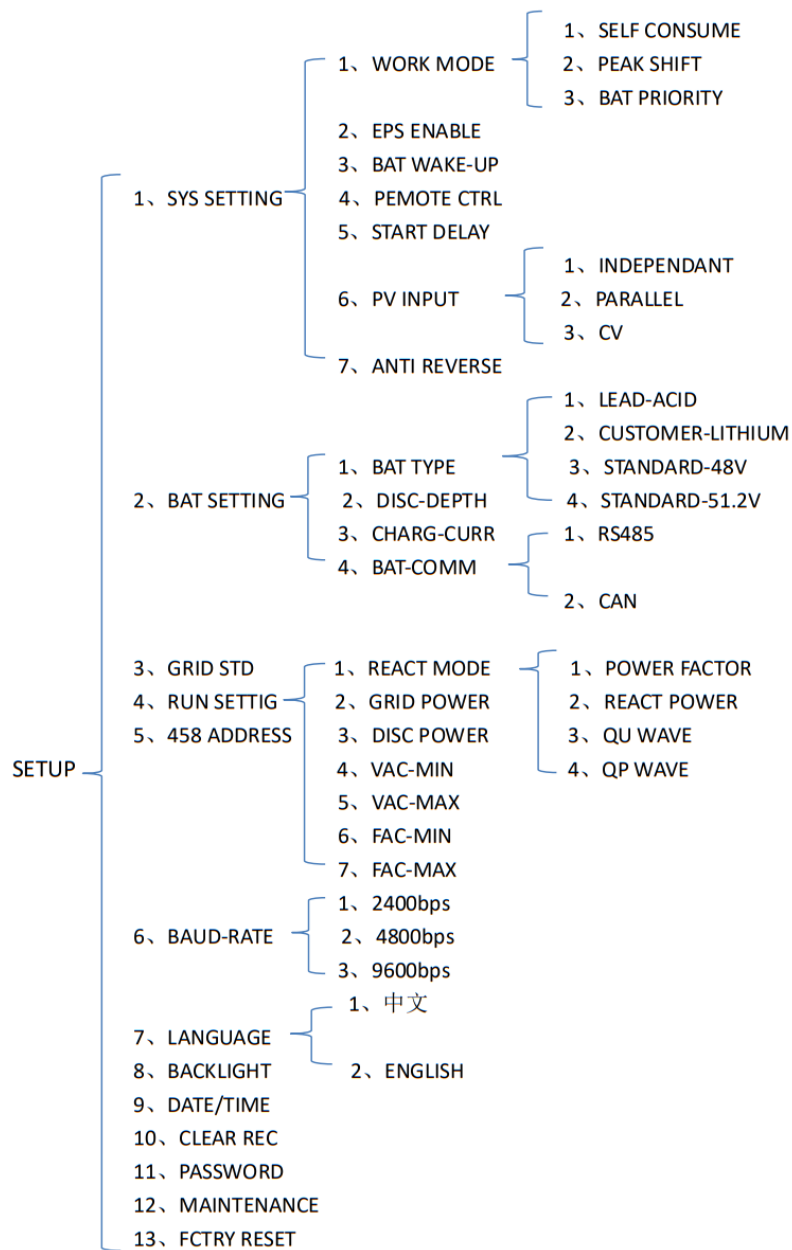

Figure 2.1.6.10 Setting options

Please refer to the [Megarevo inverter manual](#) for more settings.



Connect the cables and set the DIP Switch

Connect the power cables between inverter and battery or the Busbars as mentioned in Section 2 inverter connection. See the Figure 2.1.7.1 to check the position of Luxpower Battery Connectors.

A standard ethernet cable can be used for the communication since Luxpower inverter pin assignment is the same as Pytes E-BOX battery.

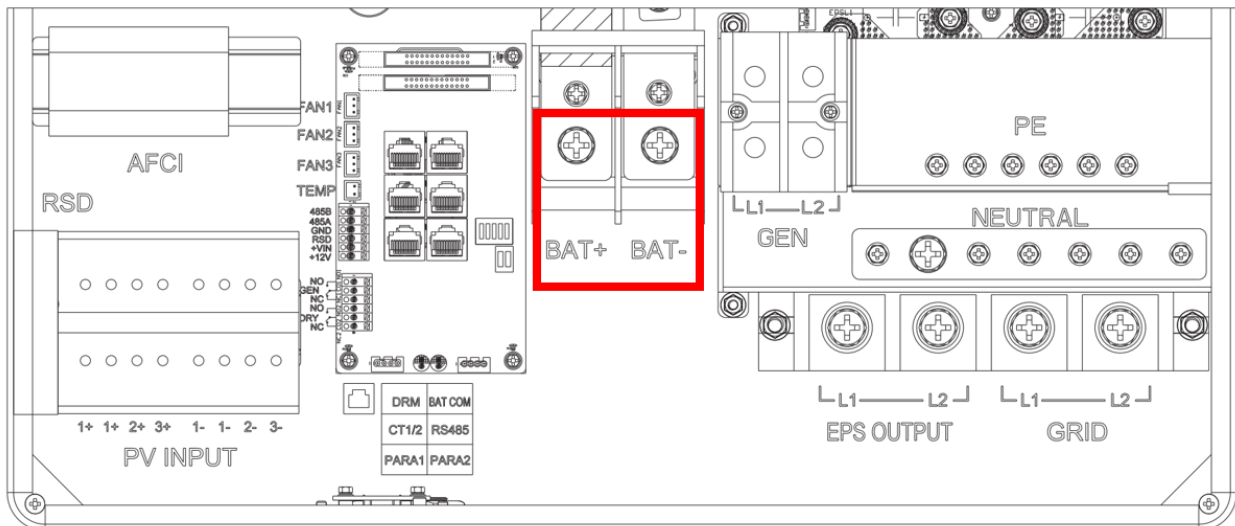

Figure 2.1.7.1 Luxpower Battery Connectors

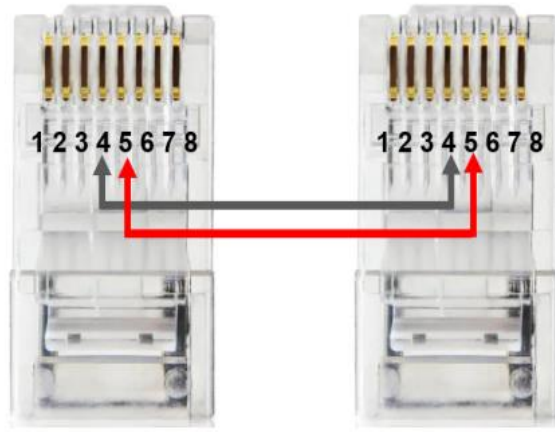

Figure 2.1.7.2 Luxpower ethernet cable

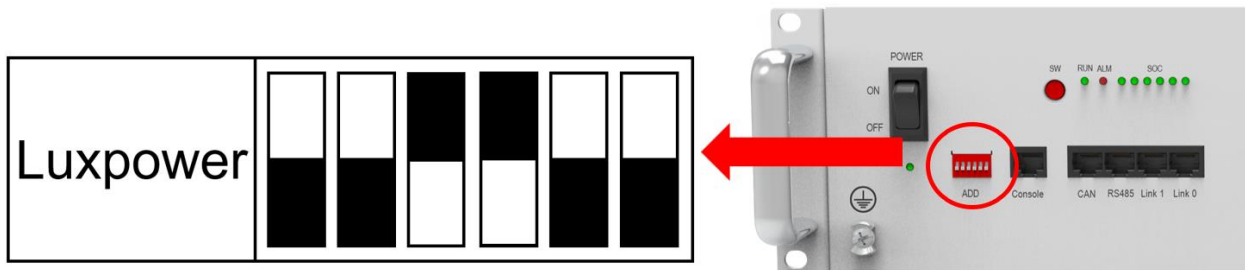

Figure 2.1.7.3 Luxpower DIP switch setting

Plug in the battery end into the **RS485 port** of the Pytes E-BOX battery and plug in the inverter end into Luxpower **BAT COM Port** as shown in the Figure 2.1.7.4.

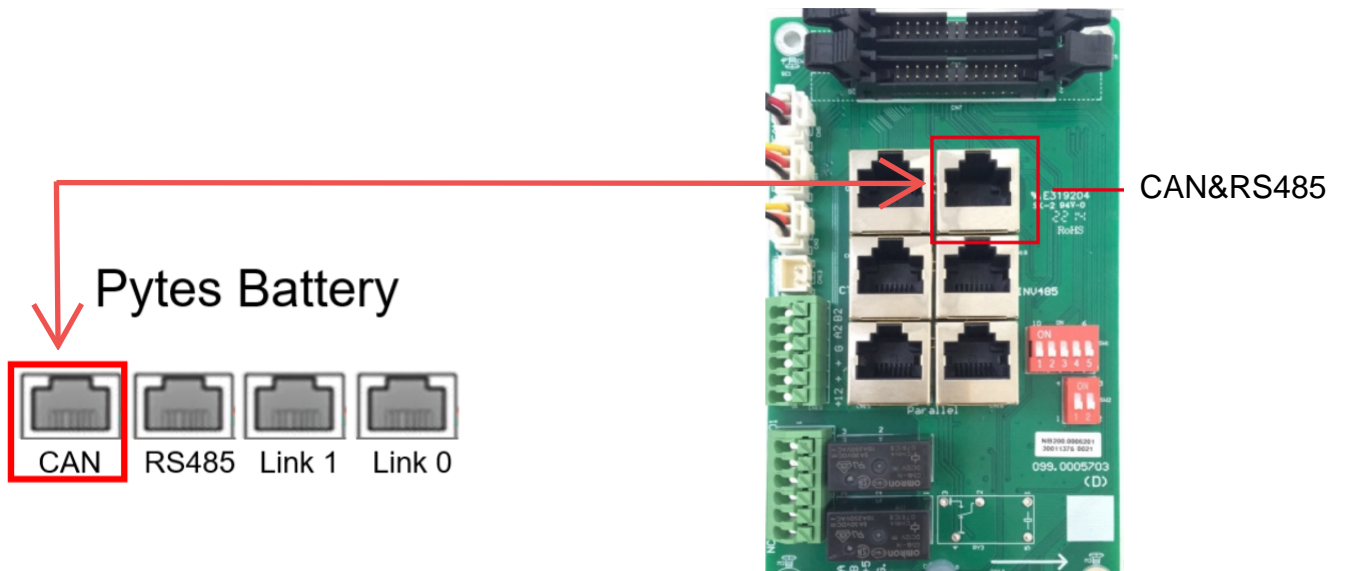

Figure 2.1.7.4 Luxpower inverter comm cable connection

Program the inverter

The operation and display panel, shown in below chart, are on the front panel of the inverter. It includes three indicators, four function keys and LCD display, indicating the operating status and input/output power information. (shown in the Figure 2.1.7.5)

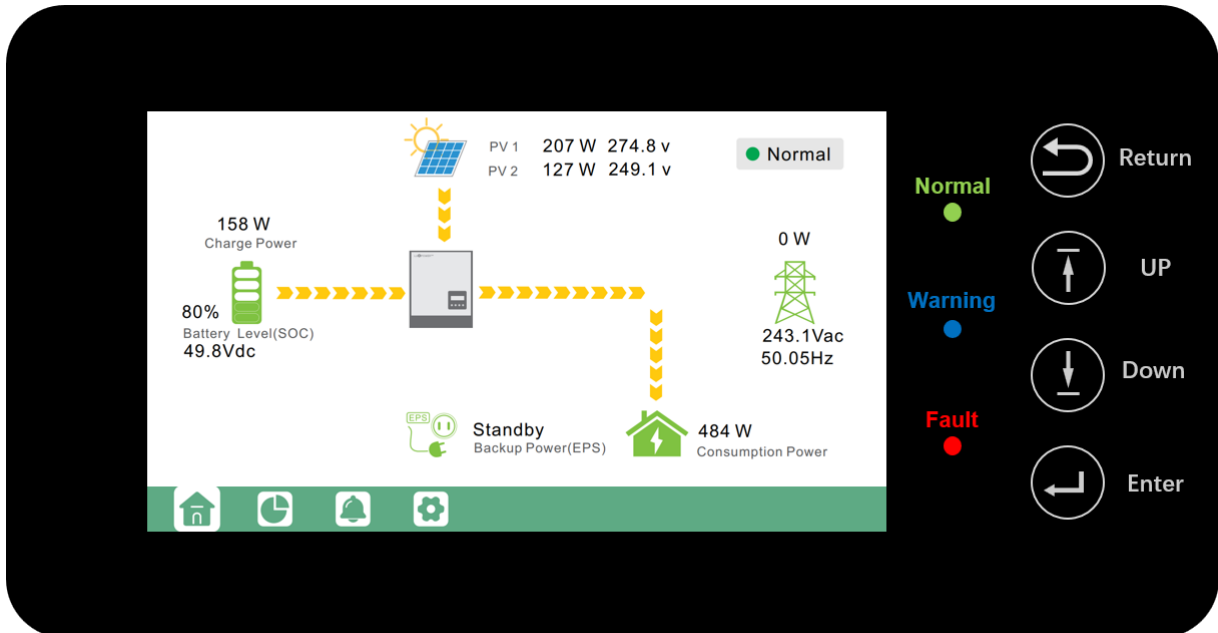

Figure 2.1.7.5 Luxpower operation panel

STEP 1 Touch the screen to light it up if it's in sleep mode, and touch the “Setting” button as shown in the Figure 2.1.7.6.

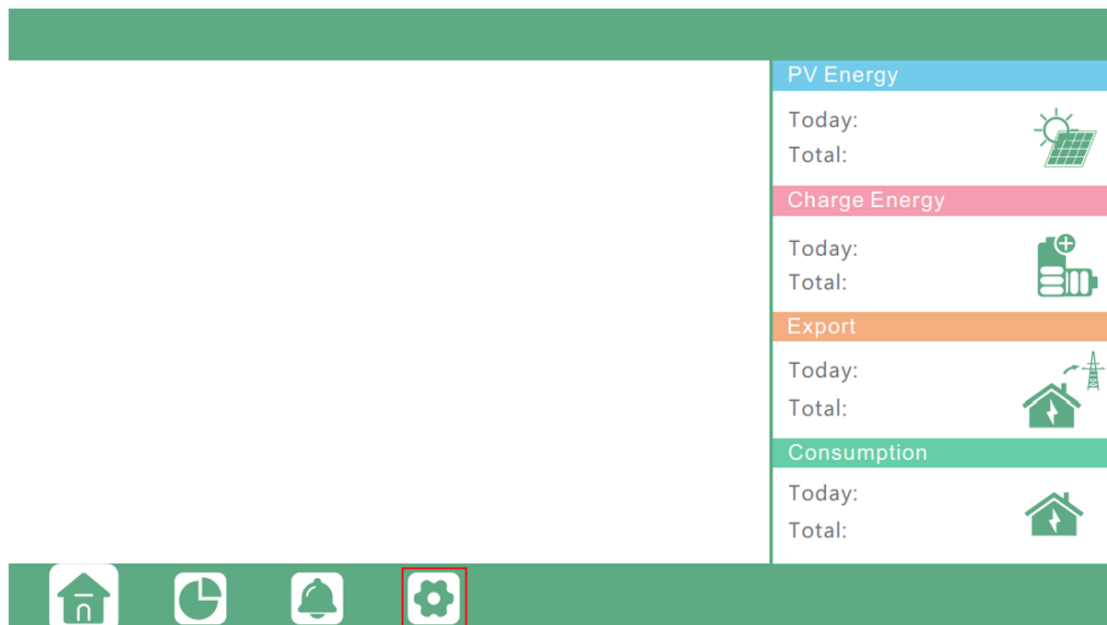

Figure 2.1.7.6 Home page

STEP 2 Touch the “Charge” button and select the “Charge first (PV)” mode. (This mode is

suitable for scenarios users want to use solar power to charge battery, grid power to supply load, and the priority order of solar power usage will be Battery >Load >Grid)

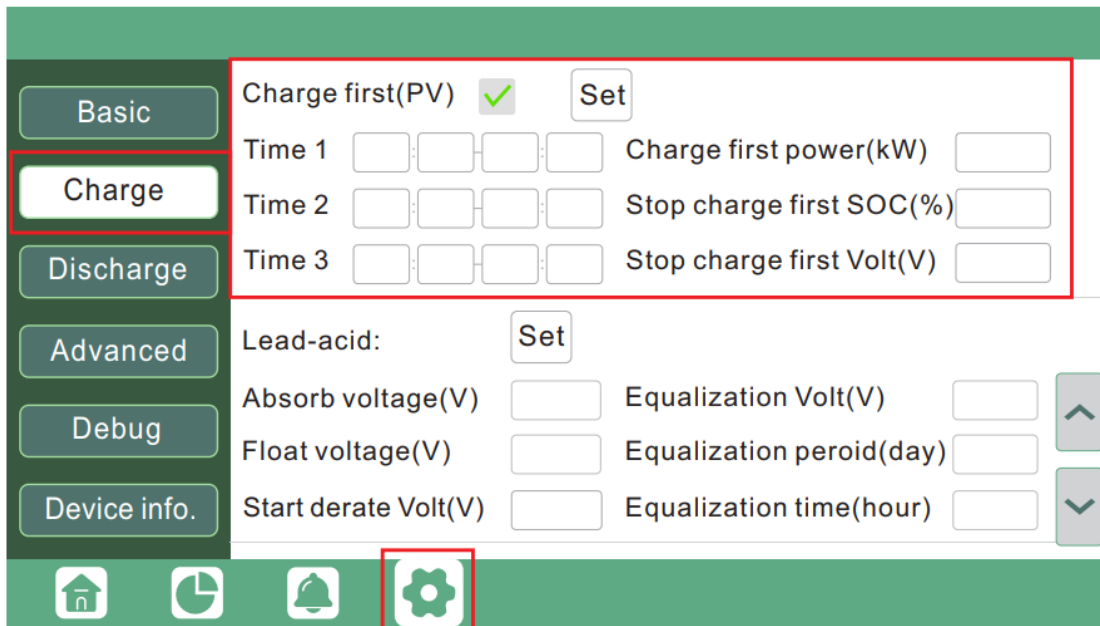

Figure 2.1.7.7 Charge first(PV) mode

If you want to charge battery with grid power when electricity price is cheap, and discharge battery power to supply load or export to the grid when electricity price is high, you could select “AC charge” mode. (This mode is suitable for scenarios users have a Time of Use(TOU) rate plan)

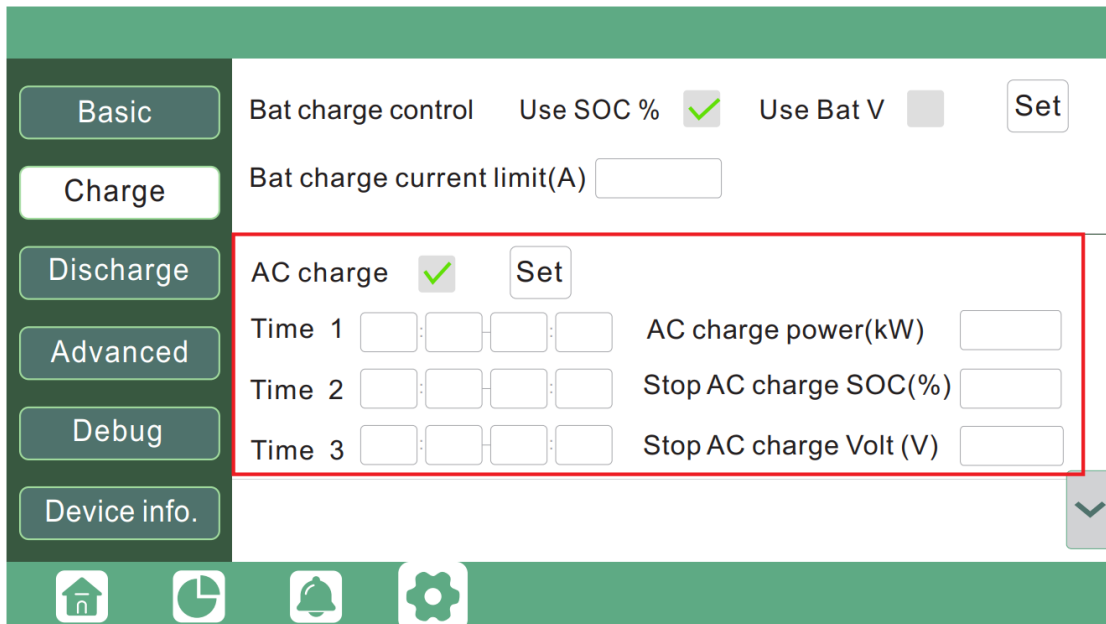

Figure 2.1.7.8 AC Charge Mode

Please refer to the [Luxpower inverter manual](#) for more settings.

2.2 Open loop communication



All Open Loop Settings are programmable with a SCP, Insight Local or/and Insight Cloud. Disregard the communication cable that would go from battery to inverter.

Settings for Pytes Batteries with Schneider Inverters

Charger Setting > Custom Setting	
Battery Type	Custom
Charge Cycle	2StgNoFloat
Bulk Voltage	56 V
Max Bulk Current	50A per battery
Max Discharge Current	50A per battery
Battery Capacity	100 Ah per battery
Max Charge Rate Percentage (%)	50A per battery Divided by Total Inverter DC Amps*
Default Battery Temperature	Warm
Recharge Volts	51.2 V
Grid Support Volts	53 V
Absorb Volts	56 V
Absorb Time	1 hour
Charge Block Start	Default
Charge Block Stop	Default
Advanced Setting > Inverter Settings	
Low Battery Cut Out Voltage	47 V
LBCO Hysteresis	2.0 V
LBCO Delay	5 Sec
High Battery Cut Out Voltage	56.5 V
Search Watts	Default
Search Delay	Default

Settings with Schneider Charge Controllers

Parameter Setting for Pytes Batteries with Schneider XW+&XW Pro MPPT 60/80

Advanced Setting > Charger Setting	
Battery Type	Custom
Custom Setting	
Charge Mode	3 Stage
Eqlz Mode	Disabled
Bulk Voltage	56.2 V
Absorb Voltage	56.2 V
Absorb Time	60 minutes
Float Voltage	55.8 V
Battery Temperature Compensation	0mV/C
Battery Capacity	100Ah per battery
Max Charge Rate Percentage	50 A per battery Divide by total CC amp output
Charge Cycle	Warm
Recharge Volts	53 V
Absorb Time	1 Hour
Default Battery Temperature	Warm
Battery Voltage (Auto-detected)	51.2 V

Note: The charge controllers can be set to a 3 stage charging cycle, but the inverter should be kept in a 2 stage charging cycle. Doing so, as well as setting the charge controller recharge voltage to be greater than that of the inverter recharge voltage, will prioritize charge controller charging over the inverter charging. Inverter charging is a grid/generator charge which has a lower priority than solar charge controller charging.

Please refer to [XW Pro Commissioning Guide - Schneider Electric Solar](#) for more information.

Integrating with a Radian/FXR

The following charge settings are recommended when pairing a Pytes E-BOX 48100R battery with a single Radian or FXR system. Please consult the MATE3s Programming Guide for detailed instructions on how to adjust the settings.

Radian	Setting
Absorb Voltage and Time	56 Vdc/ 2.0hr
Float Voltage and Time	55.6 Vdc/ 0.0hr
Re-float Voltage	52.4 Vdc
Re-bulk Voltage	51.2 Vdc
AC Charger Limit (A_{AC})	30 Aac
Low Battery Cutout	47 Vdc
LBCO Delay	120 seconds
Low Battery Cut-in	48 Vdc
High Battery Cutout	56.5 Vdc
HBCO Delay	10 seconds
High Battery Cut-in	55.5 Vdc
Sell Voltage	53.2 Vdc
Charge Controller	
Absorb Voltage	56.2 Vdc/ 2.0hr
Float Voltage	55.8 Vdc
Re-bulk Voltage	51.4 Vdc
DC Current Limit	60/80/100 Adc*
Absorb End Amps	0 Adc
FN-DC	
Battery Ah	100 Ah per E-BOX 48100R
Charged Voltage	56 Vdc
Charged Return Amps	6.5 Adc
Battery Charge Efficiency	95%
MATE3s	
FN-DC Advanced	Low/Critical SOC Warning = 10%/ 15%

Integrating with a SkyBox

The settings below should be programmed under the Custom choice. Please consult the [SkyBox Programming Guide](#) for detailed instructions on how to adjust these settings.

SkyBox	Setting
Maximum SOC	100%
Minimum SOC	10%
Absorb Charge	Timed
Absorb Voltage	56 Vdc
Absorb Voltage	02:00
Float Charge	Disabled
Float Voltage	Can be left at default
Float Time	Can be left at default
Re-float Voltage	51 Vdc
Re-bulk Voltage	50.4Vdc
Equalize Voltage	56 Vdc
Minimum Equalize Time	00:00
Max Charge Current (Adc)	100 Adc*
Grid Charge Limit (kW)	Site specific
Low Battery Cutout	47 Vdc
LBCO Delay	120 seconds
Low Battery Cut-in	48 Vdc
High Battery Cutout	56.5 Vdc
HBCO Delay	10 seconds
High Battery Cut-in	55.5 Vdc
Battery Series	Custom
Battery Model Number	Custom
Battery Description	Pytes E-BOX 48100R
Battery Total Amp-Hours	100 x (Number of Batteries)
Charge Efficiency Factor	95%
Absorb End Amps	6.5 Adc

*Ensure the maximum battery charging current is not exceeded after all charge controllers are taken into consideration. (i.e. – 2 FM100 controllers would charge at 200 Adc, a violation of the limit if only one E-BOX 48100R is used.)



The following charge settings are recommended when pairing a Pytes E-BOX 48100R battery with a Magnum system. Please consult the Magnum Programming Guide for detailed instructions on how to adjust the settings.

Magnum MS4448PAE Inverter Battery Turn On/Off Levels Setting

Parameters	Setting
Low Battery Cutout	47 Vdc
LBCO Delay	120 seconds
Low Battery Cut-in	48 Vdc
High Battery Cutout	56.5 Vdc
HBCO Delay	10 seconds
High Battery Cut-in	55.5 Vdc

Low Battery - The inverter will shut off whenever the battery voltage falls to the LBCO (Low Battery Cut Out) level to protect the batteries from being over-discharged. After the inverter has reached the LBCO level and turned off, the inverter will automatically restart after one of the following conditions:

- AC Power is applied and the inverter begins operating as a battery charger.
- Battery voltage rises to the LBCI (Low Battery Cut In) level.

High Battery - In the event the battery voltage approaches the HBCO (High Battery Cut Out) level, the inverter will automatically shut down to prevent the inverter from supplying unregulated AC output voltage. The inverter's status LED turns off when a high battery fault condition occurs. The inverter will automatically restart when the battery falls to the HBCI (High Battery Cut In) level.

*High battery voltage may be caused by excessive or unregulated voltage from the solar panels or other external charging sources.

Magnum MS4448PAE Inverter/Charge

Parameters	Setting
Shore Max	30A
01 Search Watts	5W
02 LowBattCutOut	47 Vdc
03 Batt AmpHrs	100 Ah per E-BOX 48100R
04 Battery Type	48 Vdc models
05 Charge Rate**	100%
06 VAC Dropout	80 Vac

- Shore Max - This setting ensures the inverter AC loads receive the maximum current available from the utility or generator power. When the total current used to power the AC loads and charge the batteries begins to approach the Shore Max setting, the current that was used for charging the batteries will automatically be reduced.
- 01 Search Watts - This setting allows you to turn off the power-saving Search Mode circuitry or adjust the power level at which the inverter will “wake up” and start inverting.
- 02 Low Battery Cut Out Voltage - This setting determines when the inverter will turn off based on low battery voltage. The inverter turns off automatically after the battery voltage has been below this setting for more than one minute. This protects the batteries from over-discharge and the AC loads from unregulated power (brown-outs).
- 03 Batt AmpHrs (see “Max Bulk and/or Discharge Current”) - This setting allows the user to input the battery bank size in amp hours which tells the charger how long to charge the batteries in the Absorb charge stage.
- 04 Battery Type - Sets the type of batteries being used in the system; this information tells the charger what voltage level to use to charge the batteries.
- 05 Charge Rate - This setting can be used to turn off the charger, limit the amount of current that the charger can use (leaving more current available to power loads); or to ensure small battery banks are not overheated because of a charge rate that is too high.
- 06 VAC Dropout - Sets the minimum AC voltage that must be present on the AC input before the unit transfers from Standby Mode to Inverter Mode. This protects the AC loads from utility outages and brown-outs. On MS-PAE models, when two inputs (leg 1 and leg 2) are used, the VAC Dropout voltage is determined by the sum of the two inputs ÷ 2. For example, if input 1 = 120VAC and input 2 = 110 VAC, the sum (230) ÷

2 = 115. In this example, 115 VAC is what the inverter's AC input is sensing to determine when to stay connected or disconnect and start in.

In a DC coupled system, solar controller(s) must be used to regulate the PV power and charge the batteries. Please select the Charge controller which are compatible with Pytes E-BOX batteries. We use MAGNUM PT-100 MPPT Charge Controller as example here.

Parameter	Setting
Battery Type	Custom
Eqlz Support	Disable
Bulk Voltage	56.2 Vdc
Absorb Voltage	56.2 Vdc
Float Voltage	55.8 Vdc
EQ Volts	Set to the same value as Absorb Volts
EQ Done Time	N/A
Absorb Done Time	1 hr
Absorb Done Amps	2 A
Battery Capacity	100 Ah per E-BOX 48100R
Max Charge Rate	50 A per E-BOX 48100R
Max Charge Time	12hr
Bulk Starts	51 Vdc
Daily/ Sunup	YES, to set the PT-100 to start a Bulk charge cycle each new day at sun-up
Bulk Start Volts	50.4 Vdc
Bulk Start SOC	50% (ME-BMK is required for this setting)
Battery Temp Compensation	0mV/C
PT Alarm	PT controller can be programmed for a low battery voltage alarm

Please refer to [Magnum User Manual](#) for more information.

Changelog Notes

Version	Changelog	Author/Editor	Date
1.0	Initial creation	Mady	8/8/2022
1.1	Added Victron	Cris	8/16/2022
	Added Schneider	Mady	8/16/2022
1.2	Added Solis	Cris	8/29/2022
1.3	Added Megarevo, Growatt, Luxpower	Cris	9/6/2022