

Smart choice for power

**xantrex**

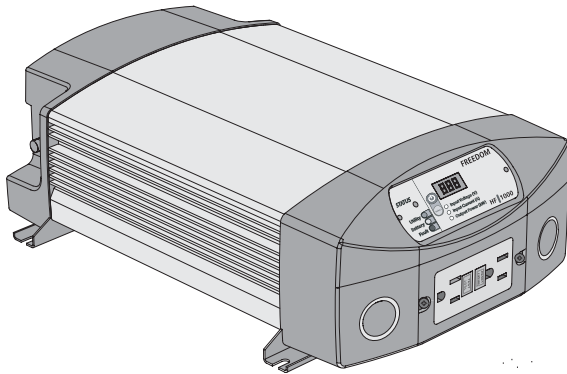

**Freedom HF 1000  
Freedom HF 1800**

**Installation Guide**

**Freedom HF  
Inverter/Charger**

[www.xantrex.com](http://www.xantrex.com)

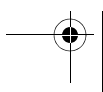
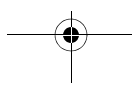
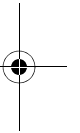
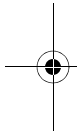
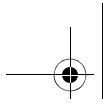

Smart choice for power

**xantrex**

# Freedom HF Inverter/Charger

## Installation Guide

This guide for use by qualified installers only

## About Xantrex

Xantrex Technology Inc. is a world-leading supplier of advanced power electronics and controls with products ranging from small mobile units to utility-scale systems for wind, solar, batteries, fuel cells, microturbines, and backup power applications in both grid-connected and stand-alone systems. Xantrex products include inverters, battery chargers, programmable power supplies, and variable speed drives that convert, supply, control, clean, and distribute electrical power.

## Trademarks

**Freedom HF Inverter/Charger** is a trademark of Xantrex International. Xantrex is a registered trademark of Xantrex International.

Other trademarks, registered trademarks, and product names are the property of their respective owners and are used herein for identification purposes only.

## Notice of Copyright

**Xantrex Freedom HF Inverter/Charger Installation Guide** © December 2007 Xantrex International. All rights reserved.

## Exclusion for Documentation

UNLESS SPECIFICALLY AGREED TO IN WRITING, XANTREX TECHNOLOGY INC. ("XANTREX")

(A) MAKES NO WARRANTY AS TO THE ACCURACY, SUFFICIENCY OR SUITABILITY OF ANY TECHNICAL OR OTHER INFORMATION PROVIDED IN ITS MANUALS OR OTHER DOCUMENTATION.

(B) ASSUMES NO RESPONSIBILITY OR LIABILITY FOR LOSSES, DAMAGES, COSTS OR EXPENSES, WHETHER SPECIAL, DIRECT, INDIRECT, CONSEQUENTIAL OR INCIDENTAL, WHICH MIGHT ARISE OUT OF THE USE OF SUCH INFORMATION. THE USE OF ANY SUCH INFORMATION WILL BE ENTIRELY AT THE USER'S RISK; AND

(C) REMINDS YOU THAT IF THIS MANUAL IS IN ANY LANGUAGE OTHER THAN ENGLISH, ALTHOUGH STEPS HAVE BEEN TAKEN TO MAINTAIN THE ACCURACY OF THE TRANSLATION, THE ACCURACY CANNOT BE GUARANTEED. APPROVED XANTREX CONTENT IS CONTAINED WITH THE ENGLISH LANGUAGE VERSION WHICH IS POSTED AT [WWW.XANTREX.COM](http://WWW.XANTREX.COM).

## Date and Revision

December 2007 Rev A

## Part Number

975-0395-01-01

## Product Numbers

806-1020 (Freedom HF 1000)

806-1840 (Freedom HF 1800)

## Contact Information

Telephone: 1 800 670 0707 (toll free North America)  
1 408 987 6030 (direct)

Fax: 1 800 994 7828 (toll free North America)

Email: [customerservice@xantrex.com](mailto:customerservice@xantrex.com)

Web: [www.xantrex.com](http://www.xantrex.com)

This guide for use by qualified installers only

# About This Guide

## Purpose

The purpose of this **Installation Guide** is to provide explanations and procedures for setting up and installing a **Freedom HF Installation**\*.

For complete information on how to operate, maintain, and troubleshoot the **Freedom HF** unit, see the **Freedom HF Inverter/Charger Owner's Guide (Doc. Part Number: 975-0390-01-01)**

\* *Recreational, Fleet Vehicle, or Marine installation.*

## Scope

The **Guide** provides safety guidelines, detailed planning and setup information, as well as procedures for installing the inverter/charger unit. It does not provide details about particular brands of batteries. You need to consult individual battery manufacturers for this information.

## Audience

The **Guide** is intended for anyone who needs to install a **Freedom HF Inverter/Charger** installation. Installers should be technicians or electricians who are certified for the type of specific installation.

## Organization

This **Guide** is organized into two chapters and two appendixes.

Chapter 1 provides information to help in installing a Freedom HF Inverter/Charger Installation.

Chapter 2 explains how to configure the Freedom HF to best meet your electrical system requirements.

Appendix A contains electrical performance information and product specifications.

Appendix B illustrates a typical marine installation for the Freedom HF.

## About This Guide

---

# Conventions Used

The following conventions are used in this guide.



### **WARNING**

Warnings identify conditions or practices that could result in personal injury or loss of life



### **CAUTION**

Cautions identify conditions or practices that could result in damage to the unit or other equipment.

---

**Important:** These notes describe things which are important for you to know, but not as serious as a caution or warning.

---

## Related Information

You can find more information about Xantrex Technology Inc. as well as its products and services at [www.xantrex.com](http://www.xantrex.com)

# Important Safety Instructions

***IMPORTANT: Read and save this **Installation Guide** for future reference.***

This chapter contains important safety and installation instructions for the **Freedom HF Inverter/Charger** units—**Freedom HF 1000** and **Freedom HF 1800**.



## **WARNING: Limitations on use**

The **Freedom HF** is not intended for use in connection with life support systems or other medical equipment or devices.

1. BEFORE INSTALLING AND USING THE **FREEDOM HF**, READ ALL INSTRUCTIONS AND CAUTIONARY MARKINGS ON THE **FREEDOM HF**, THE BATTERIES, AND ALL APPROPRIATE SECTIONS OF THIS GUIDE.



## **CAUTION: Risk of injury**

To reduce the risk of injury, charge only 12 Vdc lead-acid (GEL, AGM, and Flooded) rechargeable batteries. Other battery types may burst, causing personal injury and damage.

2. Do not expose the **Freedom HF** to rain, snow, spray, or bilge water. To reduce risk of fire hazard, do not cover or obstruct the ventilation openings. Do not install the **Freedom HF** in a zero-clearance compartment. Overheating may result.
3. To avoid a risk of fire and electric shock, make sure that existing wiring is in good condition and that wire is not undersized. Do not operate the **Freedom HF** with damaged or substandard wiring.
4. The use of any attachments not recommended or sold by Xantrex, may result in risk of fire, electric shock, or injury to persons.
5. Do not operate the **Freedom HF** if it has received a sharp blow, been dropped, or otherwise damaged in any way. If the **Freedom HF** is damaged, see the Warranty section.

6. Do not disassemble the **Freedom HF**. It contains no user-serviceable parts. See **Warranty** for instructions on obtaining service. Attempting to service the **Freedom HF** yourself may result in a risk of electrical shock or fire and will void your warranty. Internal capacitors remain charged after all power is disconnected.
7. To reduce the risk of electrical shock, disconnect both AC and DC power from the **Freedom HF** before attempting any maintenance or cleaning or working on any circuits connected to the **Freedom HF**. Turning off controls will not reduce this risk.
8. The **Freedom HF** must be provided with an equipment-grounding conductor connected to the AC input ground.



### **WARNING: Explosion hazard**

1. **WORKING IN THE VICINITY OF BATTERIES IS DANGEROUS. BATTERIES GENERATE EXPLOSIVE GASES DURING NORMAL OPERATION. THEREFORE, IT IS OF UTMOST IMPORTANCE THAT EACH TIME BEFORE SERVICING THE UNIT IN THE VICINITY OF THE BATTERY, THAT YOU READ THIS MANUAL AND FOLLOW THE INSTRUCTIONS EXACTLY.**
2. This equipment contains components which tend to produce arcs or sparks. To prevent fire or explosion, do not install the **Freedom HF** in compartments containing batteries or flammable materials, or in locations that require ignition-protected equipment. This includes any space containing gasoline-powered machinery, fuel tanks, as well as joints, fittings, or other connections between components of the fuel system.
3. To reduce the risk of battery explosion, follow these instructions and those published by the battery manufacturer and the manufacturer of any unit you intend to use in the vicinity of the battery.



---

## Personal Precautions When Working With Batteries

---



**WARNING: BATTERIES PRESENT RISK OF ELECTRICAL SHOCK, BURN FROM HIGH SHORT-CIRCUIT CURRENT, FIRE OR EXPLOSION FROM VENTED GASES. OBSERVE PROPER PRECAUTIONS.**

---

1. Study and follow all of the battery manufacturer's specific precautions, such as removing or not removing cell caps while charging, and recommended rates of charge.
2. Add distilled water in each cell until battery acid reaches the level specified by the battery manufacturer. This helps to purge excessive gas from cells. Do not overfill. For a battery without cell caps, carefully follow manufacturer's recharging instructions.
3. Make sure the area around the battery is well ventilated.
4. Never smoke or allow a spark or flame near the engine or batteries.
5. Use extra caution to reduce the risk of dropping a metal tool on the battery. It could spark or short circuit the battery or other electrical parts and could cause an explosion.
6. Remove all metal items, like rings, bracelets, and watches when working with batteries. Batteries can produce a short circuit current high enough to weld metal to skin, causing a severe burn.
7. Have someone within range of your voice or close enough to come to your aid when you work near a lead-acid battery.
8. Have plenty of fresh water and soap nearby in case battery acid contacts skin, clothing, or eyes.
9. Wear complete eye protection and clothing protection. Avoid touching your eyes while working near batteries.
10. If battery acid contacts skin or clothing, wash immediately with soap and water. If acid enters your eye, immediately flood it with running cold water for at least twenty minutes and get medical attention immediately.
11. If you need to remove a battery, always remove the ground terminal from the battery first. Make sure all accessories are off so you don't cause an arc.

12. Never charge a frozen battery.
13. Clean battery terminals. Be careful to keep corrosion from coming into contact with your eyes.

#### **MARINE UNIT LOCATION**

14. Locate the **Freedom HF** unit away from batteries in a separate, well ventilated compartment.
15. Never place the **Freedom HF** unit directly above batteries; gases from a battery will corrode and damage the unit
16. Never allow battery acid to drip on the unit when reading gravity, or filling battery.
17. Do not operate the unit in a closed in area, or restrict the ventilation in any way.

#### **DC CONNECTION PRECAUTION**

18. Connect and disconnect DC output connections only after setting any marine unit switches to off position and opening AC disconnect
19. FOR MARINE INSTALLATIONS, EXTERNAL CONNECTIONS TO THE UNIT SHALL COMPLY WITH THE UNITED STATES COAST GUARD ELECTRICAL REGULATIONS(33CFR183, SUB PART I)
20. PROPER DISPOSAL OF BATTERIES IS REQUIRED. REFER TO YOUR LOCAL CODES FOR DISPOSAL REQUIREMENTS.

---

## Precautions for Using Rechargeable Appliances

---



### CAUTION: Equipment damage

---

Most rechargeable battery-operated equipment uses a separate charger or transformer that is plugged into an AC receptacle and produces a low voltage charging output.

Some chargers for small rechargeable batteries can be damaged if connected to the **Freedom HF**. Do not use the following with the **Freedom HF**:

- Small battery-operated appliances like flashlights, razors, and night lights that can be plugged directly into an AC receptacle to recharge.
- Some chargers for battery packs used in power hand tools. These affected chargers display a warning label stating that dangerous voltages are present at the battery terminals.

---

**Important:** If you are unsure about using your rechargeable appliance with the **Freedom HF**, contact the equipment manufacturer to find out if the appliance is acceptable for use with modified sine wave input voltage. See the detailed description of the **Freedom HF** waveform in [Appendix A, “Specifications”](#) under [“Electrical Specifications: Inverter Mode”](#) on page A-2.

---

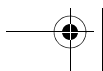
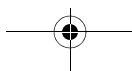
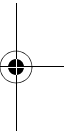
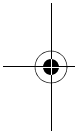
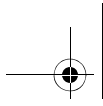

# Contents

**Important Safety Instructions** -----v

## 1 Installation

Materials List----- 1-2

Safety Instructions ----- 1-3

    Installation Codes ----- 1-3

Installation Tools and Materials ----- 1-4

High Level Overview of Installation Steps ----- 1-4

Basic Installation Procedures ----- 1-5

    Step 1: Designing the Installation ----- 1-6

    Step 2: Choosing a Location for the **Freedom HF** ----- 1-12

    Step 3: Mounting the **Freedom HF** ----- 1-13

        Connecting the Equipment Ground ----- 1-14

        Grounding Locations ----- 1-14

    Step 4: Connecting the AC Input Wires ----- 1-15

        General AC Wiring Considerations ----- 1-15

        AC Input Connections ----- 1-16

    Step 5: Connecting AC Output to an Existing AC Circuit ----- 1-19

    Step 6: Connecting the DC Cables ----- 1-24

        DC Grounding ----- 1-27

    Step 7: Mounting the Display Panel ----- 1-28

    Step 8: Testing Your Installation ----- 1-29

        Testing in Invert Mode ----- 1-29

        Testing in Shore Power Mode ----- 1-30

Drip Shield Installation (For Marine Installations) ----- 1-31

## 2. Configuration

Setting Battery Types on the Main Unit ----- 2-2

Adjusting Display, Alarm, and Charging Current Settings ----- 2-3

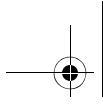

## A Specifications

Electrical Specifications: Inverter Mode-----A-2  
 Electrical Specifications: Charge Mode-----A-3  
 Environmental Specifications-----A-4  
 System Specifications-----A-4  
 Physical Specifications-----A-4  
 Regulatory Approvals-----A-4  
 Inverter Overload Operation-----A-5  
 Invert Power Derating vs. Ambient Temperature-----A-6  
 Charger Output Current vs. AC Input Voltage-----A-7

## B Marine Installation Diagram

Marine Installation-----B-2

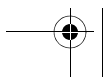
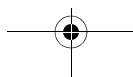
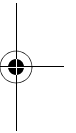
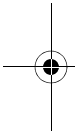

# Figures

Figure 1-1	What's In The Box	1-2
Figure 1-2	Typical Recreational Vehicle and Fleet Vehicle Installation	1-6
Figure 1-3	Approved Mounting Orientations	1-13
Figure 1-4	DC Panel Connections	1-14
Figure 1-5	<b>Freedom HF</b> AC Wiring Compartment	1-17
Figure 1-6	AC Wiring Diagram with an Inverter Subpanel	1-22
Figure 1-7	AC Wiring Diagram without an Inverter Subpanel	1-23
Figure 1-8	DC End	1-24
Figure 1-9	DC Cable Connections	1-27
Figure 1-10	Drip Shields	1-31
Figure 1-11	Typical Drip Shield Placement on a <b>Freedom HF 1800</b>	1-32
Figure 2-1	Dip Switches (Default Settings Shown)	2-2
Figure 2-2	Display Panel	2-3
Figure B-1	Typical Marine Installation	B-3

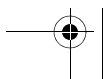
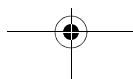
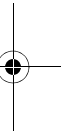
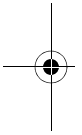
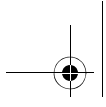



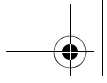

# Tables

Table 1-1	Required AC Wire Size vs Breaker Rating	-----	1-9
Table 1-2	Recommended Cable Sizes	-----	1-10
Table 1-3	Recommended Equipment Ground Cable size	-----	1-14
Table 1-4	Required AC wire size vs. required breaker rating	-----	1-16
Table 1-5	Color codes for typical AC wiring	-----	1-16
Table 2-1	Charging Current Guidelines	-----	2-5
Table A-1	Charging Voltage	-----	A-7

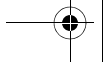
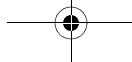
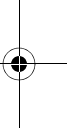
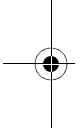

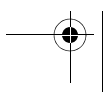
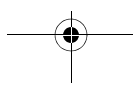
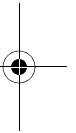
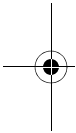
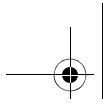

# 1 Installation

Chapter 1 provides information to help in installing a **Freedom HF Inverter/Charger** Installation.

It covers the following:

- Materials list.
- Safety instructions and various installation codes that may be applicable to your installation.
- Sample installation tools and materials.
- High level overview of installation steps.
- Installation procedures starting on [page 1–5](#) including mounting and connecting the equipment ground, AC cabling, DC cabling, and grounding steps.
- Drip shields installation (For Marine Installations).

## Materials List

Your **Freedom HF Inverter/Charger** package includes the items listed below.

- 1 **Freedom HF Inverter/Charger** unit
- 1 Display panel with 7-inch (0.17 m) cable
- 1 Communications cable (25 feet) (7.5 m)
- 2 DC terminal covers
- 2 Strain-relief clamps (for AC input and output wiring)
- 1 Blanking plate
- 2 Reference materials—an Owner's Guide and an Installation Guide
- 1 Set of mounting templates
- 1 Set of lock washers and nuts (not shown)

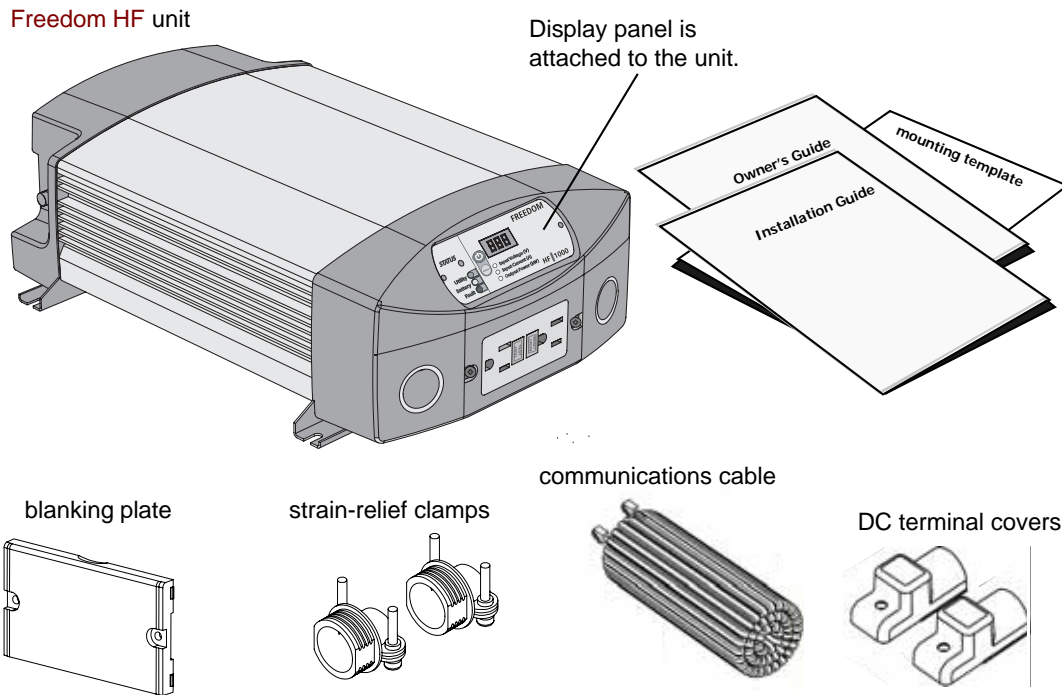

Figure 1-1 What's In The Box

## Safety Instructions



### **WARNING: Shock hazard**

Xantrex Technology recommends that all wiring be done by a certified technician or electrician to ensure adherence to the applicable electrical safety wiring regulations.

- Before you begin the installation, review the “[Important Safety Instructions](#)” on page v, and read this entire “[Installation](#)” section so you can plan your installation from beginning to end.
- Disconnect all AC and DC power sources to prevent accidental shock. Disable and secure all AC and DC disconnect devices and automatic generator starting devices.

## Installation Codes

Governing installation codes vary depending on the specific location and application of the installation. Some examples include the following:

- The U.S. National Electrical Code (NEC)
- The Canadian Electrical Code (CEC)
- The U.S. Code of Federal Regulations (CFRs)
- Canadian Standards Association (CSA) and the RV Industry Association (RVIA) for installations in RVs
- The American Boating and Yachting Committee (ABYC) for Marine installations in the U.S.

It is the installer’s responsibility to ensure that all applicable installation requirements are met.

## Installation Tools and Materials

You will need the following to install the **Freedom HF**:

- Wire stripper
- Mounting screws or bolts
- #2 Phillips screwdriver
- Wrench for DC terminals (1/2 inch or 13mm or adjustable)
- AC cable (i.e. 2-conductor-plus-ground cable), sized appropriately for load and application
- Wire nuts or crimp connectors for AC wire and appropriate tools
- Two 1/2 inch strain-relief clamps (supplied) for AC cables
- DC cable, sized appropriately for load and application
- Lugs for DC cables to fit 8 mm (5/16 in.) DC stud terminals) as well as appropriate tools (e.g. crimping tool)
- AC and DC disconnects and over-current protective devices

## High Level Overview of Installation Steps

Installing the **Freedom HF** includes the following steps.

1. Ensure that AC and DC power are both OFF.
2. Mount the inverter securely and permanently in one of the acceptable orientations.
3. Connect the Equipment Grounding Terminal to the equipment ground bus.
4. Connect the AC input wiring to the AC source panel.
5. Connect the AC output wiring to the AC load panel.
6. Connect one end of the DC negative cable to the negative of the battery, and the other to the negative terminal of the unit.
7. Install an appropriately sized fuse and DC disconnect in the positive cable.
8. Connect the DC positive cable to the positive of the battery, and to the positive terminal of the unit.
9. Close the DC disconnect switch.

Do not proceed with installation until you have read [“Safety Instructions” on page 1–3](#).

## Basic Installation Procedures

Xantrex recommends that you have your installation performed by a qualified technician or electrician.

This section provides sample installation information as a guide for your installation. For your convenience, the overall procedure is divided into ten main steps:

- Step 1:** Designing an installation. (Start on [page 1–6.](#))
- Step 2:** Choosing a location for the **Freedom HF**. (Start on [page 1–12.](#))
- Step 3:** Mounting the **Freedom HF**. (Start on [page 1–13.](#))
- Step 4:** Connecting the AC input wires. (Start on [page 1–15.](#))
- Step 5:** Connecting the AC output wires. (Start on [page 1–19.](#))
- Step 6:** Connecting the DC cables. (Start on [page 1–24.](#))
- Step 7:** Mounting the display panel. (Start on [page 1–28.](#))
- Step 8:** Testing your installation. (Start on [page 1–29.](#))

## Step 1: Designing the Installation

Most **Freedom HF** installations share common components, and some of these are briefly described below. **Figure 1-2** shows some components and their relationship to each other in a typical recreational vehicle or fleet vehicle installation. (Also, see “**Marine Installation Diagram**” on page B-1.)

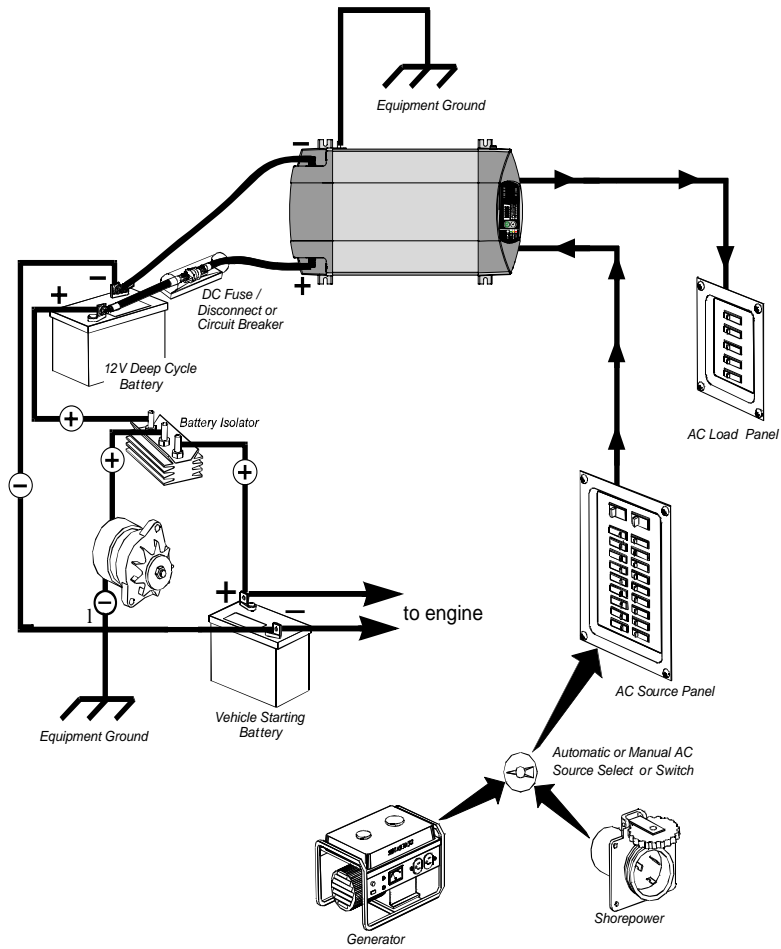

Figure 1-2 Typical Recreational Vehicle and Fleet Vehicle Installation



**AC shore power** A source of 120 V, 60Hz sine wave alternating current is needed to provide energy to charge batteries and pass power through to AC loads. This source is usually the utility grid (power company) or an AC generator. An automatic or manual AC source selector switch can be used to switch between the multiple sources of shore power to the **Freedom HF** system.

The AC source feeding the **Freedom HF** must have the neutral conductor bonded to ground. When the inverter passes shore power through, it will lift the bonding relay on the output and will rely on the input being bonded in order to ensure that the power delivered to a sub panel is properly bonded. See “[AC Output Neutral Bonding](#)” on page 1–9 for more information on bonding relay operation.

---

**Important:** Throughout this manual, the term “shore power” refers to AC input power from a utility grid, generator, or other AC source.

---

**Generator** The **Freedom HF** is compatible with most generators which produce nominal 120 Vac 60Hz sine wave AC power.

Since the DC charging current limit of the **Freedom HF** may be configured to provide as little as 2A it is possible to use very small generators with the **Freedom HF** to charge batteries. The **Freedom HF** has been tested with generators of various sizes, including some as small as 700W.

**AC Disconnect and Over-Current Protection Device** Most safety requirements and electrical codes require the **Freedom HF**'s AC and DC inputs and outputs to be provided with over-current protection (such as circuit breakers or fuses) and disconnect devices.

**AC Input:** The circuit breaker or fuse (connected through hard wiring) that is used to supply the **Freedom HF** must be rated at no more than 30A and must be approved for use on 120 Vac branch circuits. The wire used between the breaker and the **Freedom HF** input must be sized adequately to carry current up to the rating of the input breaker and in accordance with the electrical codes or regulations applicable to your installation.

**AC Output:** The circuit breaker or fuse must be rated at no more than the rating of the input breaker in the installation and must be approved for use on 120 Vac branch circuits. The wire used between the **Freedom HF** and the AC output breaker must be of adequate size to match the AC input circuit breaker's rating. The wiring from each AC output breaker to each of the loads must be adequately sized to carry the current rating of the individual AC output breaker.

**Disconnect Devices:** Each system requires a method of disconnecting the AC circuits. If the over-current protection devices are circuit breakers, they will also serve as the disconnects. If fuses are used, separate AC disconnect switches will be needed ahead of the fuses. These will have to be a branch circuit rated for 120 Vac and have an appropriate current rating.

#### AC Distribution Panels

Most systems incorporate distribution centers both ahead of the **Freedom HF** (the AC source panel) and between the **Freedom HF** and the loads (the AC load panel). An AC source panel includes a main circuit breaker, which serves as over-current protection and as a disconnect for the AC shore power supply line. Additional circuit breakers serve individual circuits, one of which serves the **Freedom HF**. The AC load panel can incorporate an AC output circuit breaker and breakers for individual load circuits.



#### CAUTION: Equipment damage

Do not connect the output of the **Freedom HF** to what is known as a "multi-wire branch circuit". These are four-wire circuits consisting of a ground, neutral, and two lines that are 180 degrees out of phase with each other (from a standard 120/240V "split phase" circuit). These circuits are commonly used in kitchens to power "split receptacles" where the top and bottom halves of a duplex receptacle are connected to different lines.

#### AC Cabling

AC cabling includes all the wires and connectors between the AC source and the **Freedom HF**, as well as all cabling between the **Freedom HF** and the AC output panels, circuit breakers, and loads. The type and size of the wiring varies with the installation and load. For example, in high vibration environments, such as marine or RV applications, wire nuts may not be acceptable, so crimp splices would be required. In other applications, flexible multiple-strand wire may be required. Installation codes usually specify solid or stranded, overall size of the conductors, and type and temperature rating of the insulation around the wire.

AC breakers and fuses must be sized to adequately protect the wiring that is installed on the input and output AC circuits of the **Freedom HF**. All breakers and wiring must be sized and connected in accordance with the electrical codes or regulations applicable to your installation. [Table 1-1](#) gives some examples of wiring sizes based on the U.S. National Electrical Code and the Canadian Electrical Code. These examples are based on using a 2-conductor-plus-ground cable rated at 75 °C, and assuming an ambient temperature of up to 30 °C. Ensure that your breakers, and fuses have suitable temperature ratings for your wiring. Other codes and regulations may also be applicable to your installation.

**Table 1-1** Required AC Wire Size vs Breaker Rating

Breaker Size	10A	15A	20A	30A
Minimum Wire Size	14AWG	14AWG	12AWG	10AWG

#### AC Output Neutral Bonding

The neutral conductor of the **Freedom HF**'s AC output circuit (i.e., AC Output Neutral) is automatically connected to the safety ground during inverter operation. When AC utility power is present and the **Freedom HF** is charging, this connection is not present, so that the utility neutral (i.e., AC Input Neutral) is only connected to utility ground at your source. This conforms to National Electrical Code, which requires that separately derived AC sources (such as inverters and generators) to have their neutral conductors tied to ground in the same way that the neutral conductor from the utility is tied to ground in only one place. Check the regulations for your specific application to ensure that the installation will comply with the necessary requirements. In other words, the AC Input Neutral and Output Neutral must be isolated from each other.

#### DC Cabling

This includes all the cables and connectors between the batteries, the DC disconnect and over-current protection device, and the **Freedom HF**. Most mobile installations require multi-strand insulated cables for flexibility and durability in high vibration environments and require disconnects and over-current devices. Electrical wiring sizes are indicated by AWG notation. Under the AWG standard, a larger gauge number indicates a smaller wire diameter. Wire size is usually marked on the larger sized cables. [Table 1-2](#) specifies the minimum recommended DC cable size and maximum fuse size for the **Freedom HF**. **The DC cables must be copper and must be rated 75 °C minimum.** The cables should be terminated with lugs that fit the DC stud terminals snugly (8 mm or 5/16 in. hole size).

**Table 1-2** Recommended Cable Sizes

Inverter/Charger	Cable Length: Battery to Inverter (one way)	Minimum Cable Size	Maximum battery Fuse Size
Freedom HF 1000	Less than 5 feet (1.5 meters)	No. 2 AWG	150 Adc
Freedom HF 1800	Less than 5 feet (1.5 meters)	No. 2/0 AWG	250 Adc

**Note:** Xantrex recommends not using a cable longer than 5 feet (1.5 meters) in each direction. Cable sizes above are based on the US National Electrical Code Table 310.17 - 75C cables, assuming an ambient temperature of 30 °C cables.

**Important:** Using the correct cable size is critical to achieving the rated performance of the Freedom HF unit. When starting a heavy load the Freedom HF can draw current surges from the battery of up to 400A. If the DC wiring is too small the voltage drop from this surge will result in a voltage at the Freedom HF terminals that is too low for the Freedom HF to operate correctly. The Freedom HF may appear to operate correctly with smaller cables until a heavy load such as a microwave or refrigerator attempts to start - then the unit may work correctly sometimes and not work correctly other times.

#### DC Disconnects and Over-Current Devices

The DC circuit from the battery to the Freedom HF must be equipped with a disconnect and over-current device. This usually consists of a circuit breaker, a “fused-disconnect,” or a separate fuse and DC disconnect. Do not confuse AC circuit breakers with DC circuit breakers. They are not interchangeable. The rating of the fuse or breaker must be matched to the size of cables used in accordance with the applicable installation codes. The breaker or disconnect and fuse should be located as close as possible to the battery, in the positive cable. Applicable codes may limit how far the protection can be from the battery.

#### Batteries

The Freedom HF uses 12-volt battery banks. Every Freedom HF system requires a deep-cycle battery or group of batteries that provide the DC current that the Freedom HF converts to AC.

Ground Fault  
Circuit  
Interrupters  
(GFCIs)

A GFCI is a device that de-energizes a circuit when a current to ground exceeds a specified value that is less than that required to blow the circuit breaker. GFCIs are intended to protect people from electric shocks and are usually required in wet or damp locations.

Installations in marine and recreational vehicles require GFCI protection of branch circuits connected to the AC output of the **Freedom HF**.

The modified sine wave output of the **Freedom HF** is not equivalent to the waveform provided by electric utilities, and compliance with UL and CSA standards requires that Xantrex test and recommend specific GFCIs that will work correctly with the **Freedom HF**.

For more information about GFCIs, see the application note "Using GFCI Receptacles on Xantrex Inverters and Inverter/Chargers" in the Document Library at [www.xantrex.com/support](http://www.xantrex.com/support).

## Step 2: Choosing a Location for the Freedom HF



### WARNING: Fire and explosion hazard

This equipment contains components that tend to produce arcs or sparks. To prevent fire or explosion, do not install the Freedom HF in compartments containing batteries or flammable materials, or in locations that require ignition-protected equipment. This includes any space containing gasoline-powered machinery, fuel tanks, or joints, fittings, or other connections between components of the fuel system.



### WARNING: Fire hazard

To reduce the risk of fire, do not cover or obstruct the ventilation openings. Do not install the Freedom HF in a zero-clearance compartment. Overheating may result.

The Freedom HF should only be installed in locations that meet the following requirements:

- Dry.** Do not allow water or other fluids to drip or splash on the Freedom HF. **Do not mount the Freedom HF in an area subject to splashing water or bilge water.**
- Cool.** Normal air temperature should be between 32 °F and 104 °F (0 °C and 40 °C)—the cooler the better.
- Ventilated.** Allow at least 5 in. (13cm) of clearance at the DC end of the Freedom HF for air flow, 1 in. (2.5cm) on each side, and 2 in. (5cm) at the AC end. The more clearance for ventilation around the unit, the better the performance. Do not allow the ventilation openings on the ends of the unit to become obstructed.
- Safe.** Do not install the Freedom HF in the same compartment as batteries or in any compartment capable of storing flammable liquids like gasoline.
- Close to the battery compartment and the AC source and load panels.** Avoid excessive cable lengths (which reduce input and output power due to wire resistance). Use the recommended cable lengths and sizes, especially between the battery banks and the Freedom HF.
- Protected from battery acid and gases.** Never allow battery acid to drip on the Freedom HF or its wiring when reading specific gravity or filling the battery. Also do not mount the unit where it will be exposed to gases produced by the batteries. These gases are very corrosive, and prolonged exposure will damage the Freedom HF.

## Step 3: Mounting the Freedom HF

### To mount the Freedom HF:

1. Remove the Freedom HF from its shipping container, verify that all components are present, and record relevant product information on “Information About Your System” on page WA-4.
2. Select an appropriate mounting location and orientation. (See Figure 1-3 below.) To meet regulatory requirements, for use in on-land applications, the Freedom HF must be mounted in one of the following orientations:

- Under a horizontal surface (see 1)
- In a horizontal position on a vertical surface (see 2)

**Note:** For marine installations, only this orientation is allowed, due to the probability of moisture finding access into the enclosure.

- On a horizontal surface (see 3)

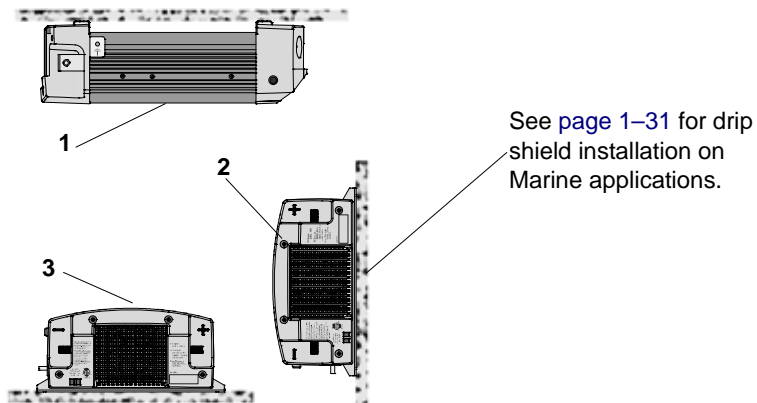

Figure 1-3 Approved Mounting Orientations

3. Look for the mounting template and unfold. Tape it to the mounting surface and pilot-drill the desired number of mounting holes. Remove the template.
4. Fasten the Freedom HF to the mounting surface. If you are mounting the unit on a wall or bulkhead, use #12 or #14 pan-head wood or sheet metal screws to secure it to the framing behind the wall or bulkhead. Alternatively, use nut inserts and 1/4-20 machine screws.

## Connecting the Equipment Ground



### WARNING: Fire hazard

Never operate the **Freedom HF** without properly connecting the equipment ground. A fire hazard could result from improper grounding.

The **Freedom HF** has a ground stud on the side of the unit as shown in **Figure 1-4**. Follow the guidelines in “**Grounding Locations**” to connect the inverter’s chassis to the ground.

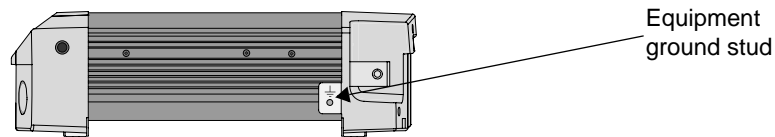

Figure 1-4 DC Panel Connections

## Grounding Locations

You must connect the equipment ground stud to a grounding point—usually the vehicle’s chassis or DC negative bus ground—using recommended copper wire (if insulated then green insulation with or without one or more yellow stripes) or larger.

For recommended equipment ground cable size, see below.

Table 1-3 Recommended Equipment Ground Cable size

Application	Minimum equipment ground cable size (Stranded cable is recommended)
Recreational Vehicle <sup>a</sup>	No. 8 AWG
Marine <sup>b</sup>	No. 3 AWG ( <b>Freedom HF 1000</b> ) No. 1/0 AWG ( <b>Freedom HF 1800</b> )

**Note:** There are no restrictions on length for the equipment ground cable.

a. Based on US National Electrical Code NFPA70, Article 551, par. 551-20c 2005 version.

b. Based on ABYC E-11 11.18 dated 07/03

In general, the equipment ground cable size must not be smaller than one AWG size than the supply cable.



## Step 4: Connecting the AC Input Wires



### WARNING: Fire, Shock and Energy hazards

Make sure wiring is disconnected from all electrical sources before handling. All wiring must be done in accordance with local and national electrical wiring codes. Do not connect the output terminals of the **Freedom HF** to any incoming AC source.

### General AC Wiring Considerations

AC Wiring Connectors	<p>Connect AC wires with crimp-on splice connectors.</p> <p>The amount of insulation you strip off individual wires will be specified by the connector manufacturer and is different for different types of connectors.</p>
AC and DC Wiring Separation	<p>Do not mix AC and DC wiring in the same conduit or panel. Where DC and AC wires must cross, make sure they do so at 90° to one another. Consult applicable codes for details about DC and AC wiring in close proximity to each other.</p>
AC Wiring Compartment	<p>For your reference, the AC Wiring Compartment is shown in <a href="#">Figure 1-5</a>.</p>
AC Wiring and GFCIs	<p>You can plug loads (12 A continuous, 15 A maximum) directly into the GFCI receptacle on the front panel of the <b>Freedom HF</b>. You can also connect the inverter to an existing AC installation and then plug loads into GFCI receptacles connected to that circuit.</p> <p>If you plan to use the <b>Freedom HF</b> with the GFCI installed on the unit, proceed to “<a href="#">Step 6: Connecting the DC Cables</a>” on page 1–24.</p> <p>If you plan to hard wire the <b>Freedom HF</b> AC input and output to an existing AC installation, read this section.</p> <p>AC wiring includes all the wires and connectors between the AC source and the <b>Freedom HF</b> and all wiring between the inverter, the AC panels, circuit breakers, and the GFCIs. The type and size of the wiring varies with the installation and load. For some RV applications, flexible multiple-strand wire is required.</p>

AC wiring must be sized appropriately to carry full load current on the input and output AC circuits in accordance with the electrical codes or regulations applicable to your installation. Table 1-4 is based on the U.S. National Electrical Code, 2003 Ed. and the Canadian Electrical Code, assuming 2-conductor-plus-ground cable, using 75 °C wiring, at an ambient temperature of 30 °C. Other codes and regulations may be applicable to your installation.

**Table 1-4** Required AC wire size vs. required breaker rating

	Required Breaker Size	Required Wire Size
<b>Freedom HF</b>	30 A maximum	10 AWG

There are two knockouts on the front panel for AC input and output wiring. Use the supplied strain relief clamps to prevent damage to the wiring from tension being applied.



### **CAUTION: Equipment damage**

The AC wiring terminal block is split into input and output sections. Damage to the inverter will occur if the unit is wired incorrectly.

When making the AC input and AC output connections, observe the correct color code for the appropriate AC wire, as described in [Table 1-5](#).

**Table 1-5** Color codes for typical AC wiring

Color	AC Wire
Black or Brown	Line
White or Blue	Neutral
Green, Green/Yellow, or bare copper	Ground

## AC Input Connections

1. Ensure that AC and DC power are both OFF.
2. Install the required circuit breaker in the AC output panel supplying the unit (See [Figure 1-6 on page 1-22](#)).
3. Remove the screws securing the GFCI AC receptacle and remove it from the front panel.
4. Disconnect the GFCI wiring, if desired.

5. Remove the left-hand side AC wiring knockout from the front panel of the unit (see [Figure 1-5 on page 1-17](#)).
6. Install one of the supplied strain-relief clamps in the AC knockout.
7. Locate the terminal block.

The two input terminals are labeled as follows:

- AC Input (L)
- AC Input (N)

A separate screw is provided to connect the AC input ground (see [Figure 1-5 on page 1-17](#)).

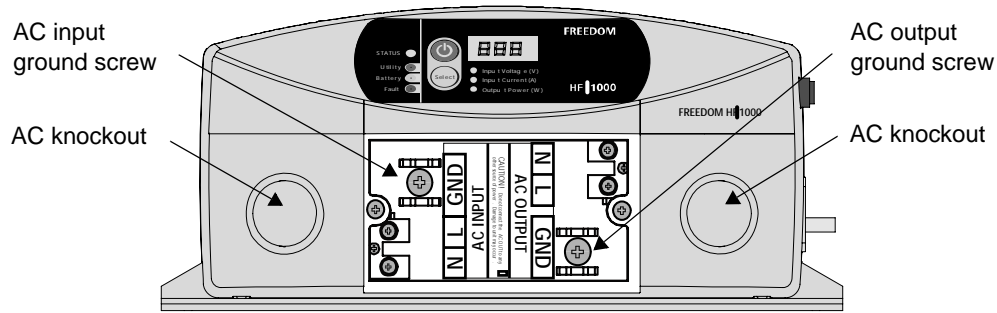

**Figure 1-5** Freedom HF AC Wiring Compartment

8. Strip about 2 inches (50 mm) from the jacket of the AC input cable. The AC input cable may be either solid or stranded (as required), but must have three conductors and be sized as in [Table 1-4 on page 1-16](#). (The AC terminal block accepts wire sizes up to No. 10 AWG.)
9. Strip approximately 3/8 inch (10 mm) from the insulation of each conductor.
10. Run the AC cable through the right-hand side strain-relief clamp and into the wiring compartment.
11. Fasten the Ground wire to the grounding screw.
12. Using the 1/8 inch slot screwdriver, loosen the wire attachment screws on the terminals.



### **CAUTION: Reverse polarity**

Improper connections (connecting a line conductor to a neutral conductor, for example) will cause the **Freedom HF** to malfunction and may permanently damage the inverter. Damage caused by a reverse polarity connection is not covered by your warranty.

13. Insert the Line and Neutral wires into the corresponding terminals.
14. Tighten the wire attachment screws to a torque of 1.3–1.8 lbf-ft (1.76–2.44 Nm). Leave some wiring slack inside the wiring compartment.
15. Secure the AC cable by adjusting the strain-relief clamps.

**If you do not plan to proceed with “Step 5: Connecting AC Output to an Existing AC Circuit” on page 1–19, follow the succeeding substep.**

16. Install the GFCI back into the front panel of the unit.

Alternatively, if you do not reinstall the GFCI, make sure that you cap the exposed wires and install a blanking plate to cover the space vacated by the GFCI.

## Step 5: Connecting AC Output to an Existing AC Circuit



### **WARNING: Shock, fire, and energy hazards**

Make sure wiring is disconnected from all electrical sources before handling. All wiring must be done in accordance with applicable local and national electrical wiring codes.



### **WARNING: Shock hazard and equipment damage**

**Do not connect any AC source (such as a generator or utility power) to the AC wiring output of the Freedom HF.**

The Freedom HF will not operate if its output is connected to AC voltage from another source, and potentially hazardous or damaging conditions may occur. These conditions can occur even if the inverter is off.

### **Do not connect the Freedom HF to an AC branch circuit that has high-power consumption loads.**

The Freedom HF will not operate electric heaters, air conditioners, stoves, and other electrical appliances that consume more than 1000 watts (Freedom HF 1000) or 1800 watts (Freedom HF 1800).

A Xantrex-tested and approved GFCI must be connected to the Freedom HF AC output, and on every receptacle connected to the AC hard wired installation. Other types may fail to operate properly when connected to the Freedom HF. Although you can reuse the factory-installed GFCI, Xantrex has also tested and approved the following GFCIs for use with the Freedom HF:

Make	Model
Hubbell	GFR5252
Leviton	6598 8598

For more information about GFCIs, see the application note “Using GFCI Receptacles on Xantrex Inverters and Inverter/Chargers” in the Document Library at [www.xantrex.com](http://www.xantrex.com).



## **WARNING: Shock, fire, and energy hazards**

Make sure wiring is disconnected from all electrical sources before handling. All wiring must be done in accordance with applicable local and national electrical wiring codes. Do not connect the output leads of the inverter to any incoming AC source.

### **To make a permanent connection to existing AC wiring (continuing from # 15 of “Step 4: Connecting the AC Input Wires” on page 1–15):**

1. Ensure that AC and DC power are both OFF.
2. Install the required value of circuit breaker in the AC load panel (see [Figure 1-6 on page 1–22](#) and [Figure 1-7 on page 1–23](#)).
3. Remove the left-hand side AC wiring knockout from the front of the unit.

**Important:** The applicable installation code may not allow you to run the AC IN and AC OUT wiring through the same AC knockout.

4. Install one of the supplied strain-relief clamps in the AC knockout.
5. Locate the terminal block.  
The two output terminals are labeled as follows:
  - AC Output (L)
  - AC Output (N)A separate screw is provided to connect the AC output ground.
6. Strip about 2 inches (50 mm) from the jacket of the AC output cable.  
The AC output cable may be either solid or stranded (as required), but must have three conductors and sized as in [Table 1-4 on page 1–16](#). (The AC terminal block accepts wire sizes up to No. 10 AWG.)
7. Strip approximately 3/8 inch (10 mm) off the insulation of each conductor.
8. Run the AC cable through the left-hand side strain-relief clamp and into the wiring compartment.
9. Fasten the Ground wire to the grounding screw.
10. Using the 1/8 inch slot screwdriver, loosen the wire attachment screws on the terminals.



### CAUTION: Reverse polarity

Improper connections (connecting a line conductor to a neutral conductor, for example) will cause the **Freedom HF** to malfunction and may permanently damage the inverter. Damage caused by a reverse polarity connection is not covered by your warranty.

11. Insert the Line and Neutral wires into the corresponding terminals.
12. Tighten the wire attachment screws to a torque of 1.3–1.8 lbf-ft (1.76–2.44 Nm). Leave some wiring slack inside the wiring compartment.

Ensure you have maintained correct polarity and that there are no loose strands of wire.

13. Secure the cable by adjusting the strain-relief clamps.
14. Install the GFCI back into the front panel of the unit.  
Alternatively, if you do not reinstall the GFCI, make sure that you cap the exposed wires and install a blanking plate to cover the space vacated by the GFCI.

15. Connect the outgoing AC wires to the AC load panel.

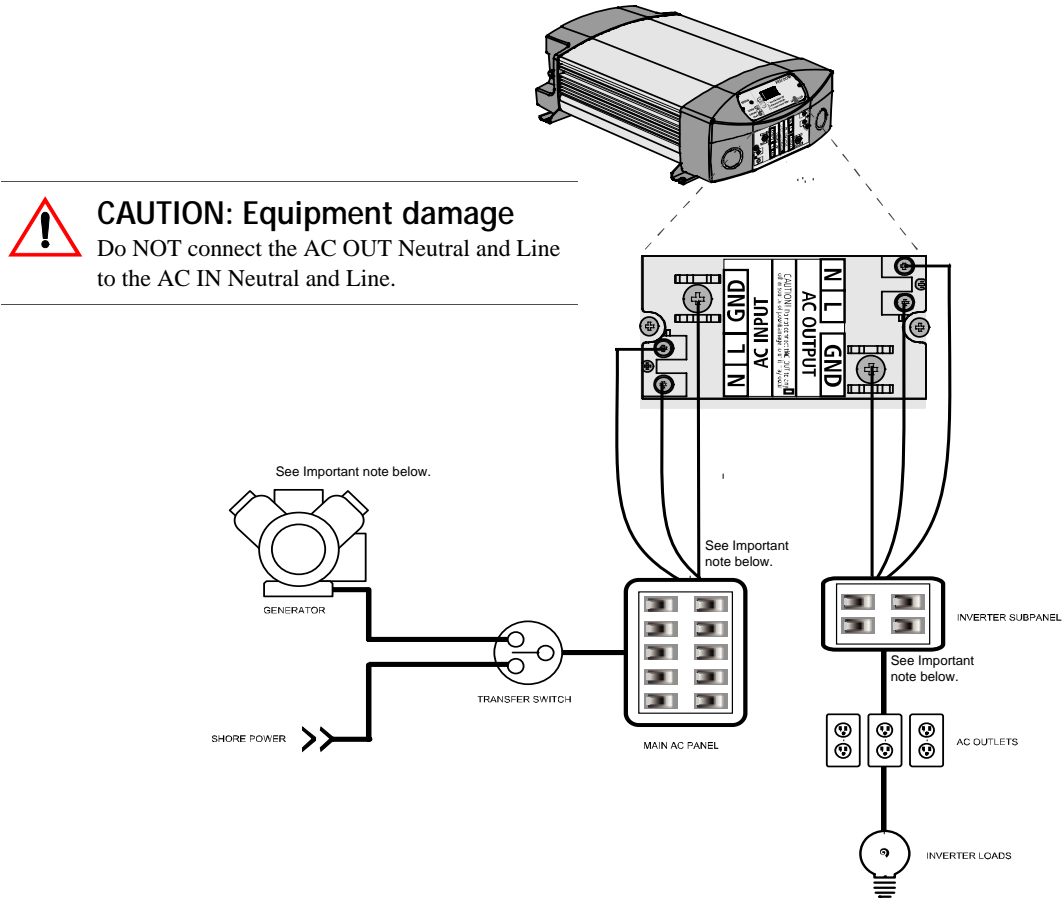

Figure 1-6 AC Wiring Diagram with an Inverter Subpanel

In this wiring diagram, the AC input to the **Freedom HF** comes from the main AC panel which contains the input circuit breaker. The AC output wiring is routed to a separate inverter subpanel with a dedicated circuit breaker.

**Important:** The generator must have its neutral bonded to ground. If it is not bonded, a bonding jumper must be installed between the neutral and ground at the generator's output or at the generator side of the transfer switch. Also, both the main AC panel and the inverter subpanel must not have a permanent neutral to ground bonds installed.





**CAUTION: Equipment damage**

Do NOT connect the AC OUT Neutral and Line to the AC IN Neutral and Line.

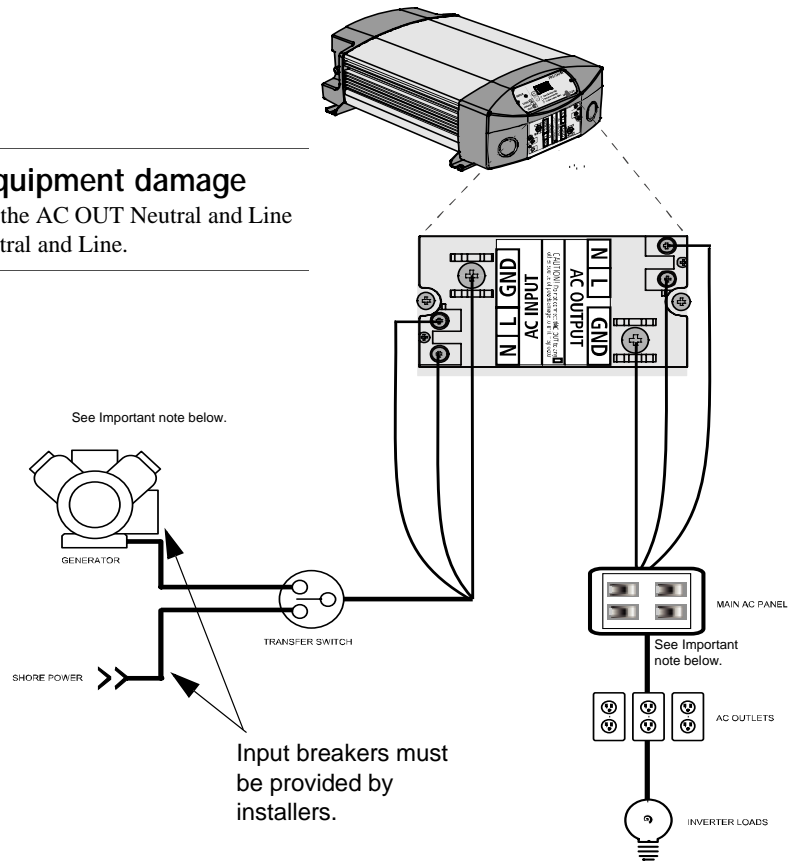

Figure 1-7 AC Wiring Diagram without an Inverter Subpanel

In this wiring diagram, the AC input to the **Freedom HF** comes directly from an AC source. The AC source input wiring must be protected by an AC breaker of 30 A max. The output wiring is routed to the main AC panel which is also protected by AC breakers or circuit breakers.

**Important:** The generator must have its neutral bonded to ground. If it is not bonded, a bonding jumper must be installed between the neutral and ground at the generator’s output or at the generator side of the transfer switch. Also, the main AC panel must not have a permanent neutral to ground bond installed.

## Step 6: Connecting the DC Cables



### CAUTION

Before making the final DC connection, check cable polarity at both the battery and the **Freedom HF**. Positive must be connected to positive; negative must be connected to negative.

Reversing the positive and negative battery cables will damage the **Freedom HF** and void your warranty. This type of damage is easily detected.



### WARNING: Fire hazard

Use only copper wire rated 75 °C minimum. Make sure all DC connections are tight to a torque of 216–240 inch-pounds (24–27Nm). Loose connections will overheat.

Follow the procedure given below to connect the battery leads to the terminals on the DC end. The cables should be as short as possible and large enough to handle the required current, in accordance with the electrical codes or regulations applicable to your installation. [Table 1-2 on page 1–10](#) specifies the minimum DC cable size and maximum fuse size for the **Freedom HF**.

Do not route your DC cables through an electrical distribution panel, battery isolator, or other device that will cause additional voltage drops.

[Figure 1-8](#) shows the DC end for your reference.

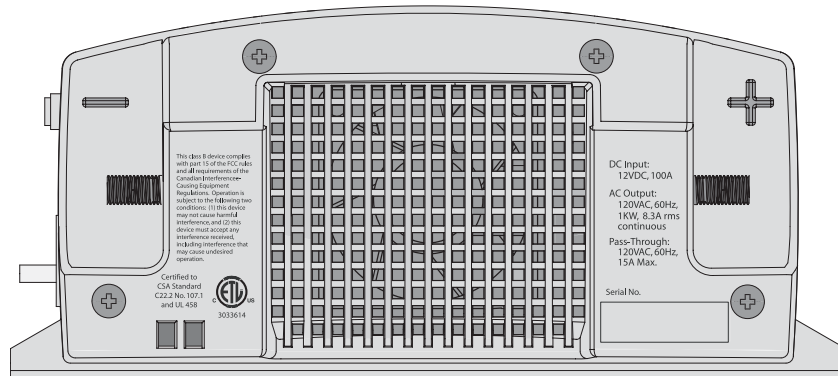

Figure 1-8 DC End

### To make the DC connections

Refer to [Figure 1-9](#).

1. Make sure the inverter is off and no AC or DC is connected to the unit.
2. Remove the nuts and washers from the **Freedom HF** positive and negative DC terminals.
3. Strip 1/2 inch (13 mm) to 3/4 inch (19 mm) insulation from one end of each cable. The amount stripped off will depend on the terminals chosen.
4. Attach the connectors that will secure the cables to the battery, to the disconnect/battery selector switch, and the fuse block. The connectors you use must create a permanent, low-resistance connection. If crimp connectors are required, Xantrex recommends using approved and certified connectors, and to use the tool recommended by the terminal manufacturer. Make sure no stray wires protrude from the connector or terminal.  
(You may find it more convenient to have the crimp connectors attached by the company that sells you the cable and/or connectors.)
5. For each cable end that will be connected to the inverter, strip 1/2 inch (13 mm) to 3/4 inch (19 mm) of insulation from the cable. The amount stripped off will depend on the terminals chosen.
6. Thread a supplied DC terminal cover over the positive and negative cables. The red cover goes on the positive cable; the black cover on the negative cable.
7. Attach the connector that will join the cable to the inverter DC terminal.
8. Install a fuse and fuse holder in the cable that will be used for the positive side of the DC circuit.  
The fuse must:
  - be as close to the battery positive terminal as possible,
  - be rated for DC circuits,
  - have an Ampere Interrupting Capacity (AIC) that exceeds the short-circuit current available from the battery (i.e., Class T fuse).

9. To prevent sparking when making the connection, ensure the disconnect/battery selector switch is off.
10. Attach the connector on the positive cable to the positive DC terminal on the inverter.
11. Install the lock washer and nut that are supplied with the inverter. Tighten the nut to a torque of 108–120 in-lbf (12.2–13.6 N-m). Make the connection snug enough so the ring terminal does not move around on the DC terminal, but do not overtighten. See [Figure 1-9, “DC Cable Connections”](#) on page 1–27.



### CAUTION

Loose connections cause excessive voltage drop and may cause overheated wires and melted insulation.



### CAUTION

Do not over-tighten the nut on the DC input terminals. Damage to the DC input terminals may result.

The maximum torque setting is **120 in-lbf (13.6 N-m)**.



### CAUTION: Reverse polarity

DC power connections to the **Freedom HF** must be positive to positive and negative to negative.

A reverse polarity connection (positive to negative) will blow a fuse in the inverter and may permanently damage the inverter. The fuse is not user replaceable and the inverter may need to be returned for servicing.

Damage caused by a reverse polarity connection is not covered by your warranty.

12. Before proceeding, double check that the cable you have just installed connects the positive DC terminal of the inverter to the disconnect/battery selector switch, fuse holder, and that the other end of the fuse holder is connected to the positive terminal of the battery.



### WARNING: Explosion or fire

Do not complete the next step if flammable fumes are present. Explosion or fire may result if the disconnect/battery selector switch is not in the off position.

Thoroughly ventilate the battery compartment before making this connection.

13. Connect the cable from the negative post of the battery to the negative DC terminal of the inverter.

14. Install the lock washer and nut that are supplied. Tighten the nut to a torque of 108–120 in-lbf (12.2–13.6 N-m). Make the connection snug enough so the ring terminal does not move around on the DC terminal, but do not overtighten.
15. Slip the DC terminal covers over the **Freedom HF** DC terminals.

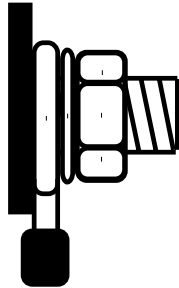

Figure 1-9 DC Cable Connections

## DC Grounding

### To connect the DC ground:

The equipment grounding lug on the DC end of the **Freedom HF** is used to connect the chassis of the **Freedom HF** to your system's DC negative connection or grounding bus point as required by electrical regulations. Use copper wire that is either bare or provided with green insulation. Do not use the DC Ground Lug for your AC grounding. (See the AC wiring instructions in this section.)

Follow the guidelines below that correspond to the specific type of installation. These guidelines assume you are using the DC supply cable and fuse sizes recommended in this manual. If you are using different sizes, refer to the applicable installation code for DC grounding details.

- **Recreational Vehicle** Use 8AWG copper wire and connect it between the Chassis Ground lug and the vehicle's DC grounding point (usually the vehicle chassis or a dedicated DC ground bus).
- **Marine** Use copper wire that is bare or has insulation rated min. 105 °C, and connect it between the Chassis Ground lug and the boat's DC grounding bus or engine negative bus. For the **Freedom HF 1000**, use a wire of gauge 4AWG minimum. For the **Freedom HF 1800**, use a wire of gauge 1/0AWG minimum.

## Step 7: Mounting the Display Panel

The communications cable supplied with the display panel is 25 feet (7.62 meters) long. If you want to replace the cable with one that is shorter, use a high quality, 6-wire telephone extension cable.

Flush mounting the panel on a wall, bulkhead, or panel requires an opening that is approximately  $3.25 \times 1.25$  inches ( $8.25 \times 3.18$  cm). About 1.5 inches (3.81 cm) of free space is required within the wall to accommodate the depth of the panel. Be sure there is no wiring or other obstructions within the wall before you make an opening.

### To mount the display panel:

1. Choose a location that is dry, out of direct sunlight, free from corrosive or explosive fumes, and otherwise appropriate for mounting an electronic device.
2. Tape the mounting template (in the **Freedom HF** package) to the mounting surface and mark the locations of the mounting holes and the area to be cut away.
3. Pilot-drill the mounting holes and cut out the hole in which the panel will be inserted.
4. Route the communications cable(s) inside the wall and through the opening.
5. Insert one of the cable's connectors in either jack on the bottom of the panel.
6. Place the panel in the opening and secure it with appropriate fasteners.
7. Route the communications cable to the **Freedom HF** and insert the connector in the jack located near the battery select dip switch.

**Important:** Do not route the communications cable in parallel and in conduit with the AC and DC wires. In situations where the cable must cross with the AC and DC wires, make sure they cross at a  $90^\circ$  angle to each other.

## Step 8: Testing Your Installation



### WARNING: Shock hazard

Pressing the Inverter button to turn OFF the **Freedom HF** inverter function on display panel does not disconnect DC or AC input power to the **Freedom HF**. If shore power is present at AC input terminals, it will pass through to the AC output.

There are two tests to be performed. The first test verifies that the **Freedom HF** is inverting DC battery power and delivering AC power to its output.

The second test is intended for installations where AC input and output is hard wired to the **Freedom HF**. This test verifies that the **Freedom HF** transfers from inverter power to shore power when shore power is present.

**Note:** Shore power (pass-through) refers to the AC input power from a utility grid, generator or external AC source.

When you are ready to test your installation and operate the **Freedom HF**, close the DC fuse and Disconnect or the DC circuit breaker to supply DC power to the **Freedom HF**.

### Testing in Invert Mode

#### To test the **Freedom HF** in invert mode:

1. For hard wired installations, ensure shore power is not present.
2. Press the Inverter button to turn the inverter on.  
The status LED on the display panel glows yellow and the LED display illuminates.
3. Plug an appliance within the power rating of the inverter into the **Freedom HF** GFCI or an AC outlet hard wired to the **Freedom HF**.
4. Turn the appliance on to verify that it operates.

If the appliance operates, your installation is successful. If your installation has AC input and output hard wired to the **Freedom HF**, proceed to “[Testing in Shore Power Mode](#)”.

If the status LED on the display panel glows red, see the Troubleshooting chapter.

---

## Testing in Shore Power Mode

### To test the **Freedom HF** in shore power mode:

- ◆ With the appliance from the previous test still connected and operating, connect the shore power source.

The **Freedom HF** transfers the appliances to shore power. The status LED on the display panel will change from yellow to a ten-second flashing yellow and then green.

If the appliance operates, your installation is successful.

---

**Note:** If the Inverter button on the **Freedom HF** is turned ON, the **Freedom HF** will automatically supply the appliances with inverter power if the shore power source fails or becomes disconnected.

If the Inverter button on the **Freedom HF** is turned ON and shore power voltage is too low (less than 90 volts AC), the unit will transfer to inverter power to continue running your appliances.

---



### **WARNING: Shock hazard**

Whether or not the Inverter button is turned ON, shore power will pass through the **Freedom HF** to the output when shore power is within normal operating range.

---



## Drip Shield Installation (For Marine Installations)

The drip shield helps to protect the unit from dripping or splashing liquids, which will cause a shock hazard. Drip shields are especially useful in marine installations where water from condensation, rain, or sea may come into contact with the **Freedom HF**.



### WARNING: Shock hazard

This product is intended only for use in dry areas. Operating the unit under wet conditions may expose you to a shock hazard. Installing drip shields may not entirely protect you from this hazard. Do not operate the unit when it is wet.

You may purchase the drip shield set by contacting Xantrex. When ordering, mention part number 808-9531.

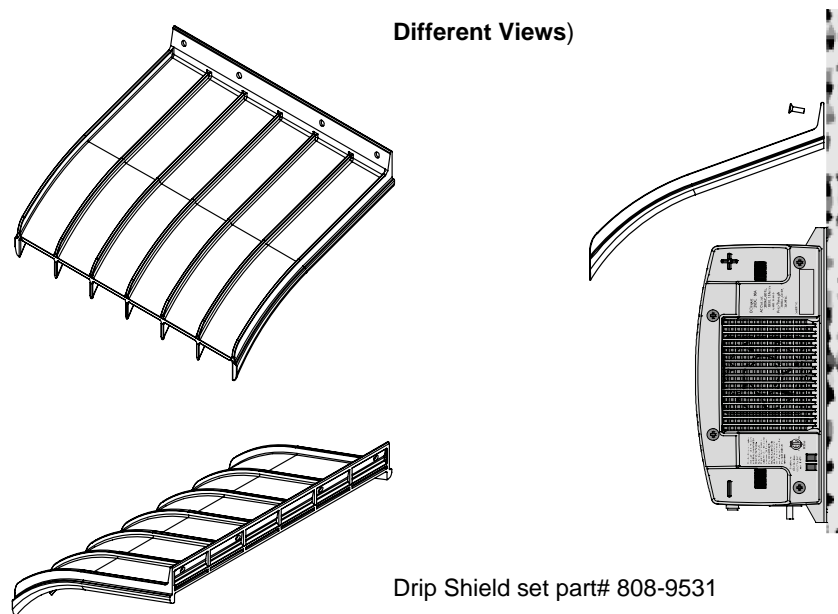

Figure 1-10 Drip Shields

### To install the drip shields:

1. Gather the four screws needed to fasten a single drip shield to a wall.
2. Locate an appropriate setting for the drip shields above the **Freedom HF** making sure you cover the entire width of the unit.

You can overlay the shields as shown in [Figure 1-11](#) below.

3. Fasten the screws through the holes in the drip shield into the wall.  
See [Figure 1-10](#).

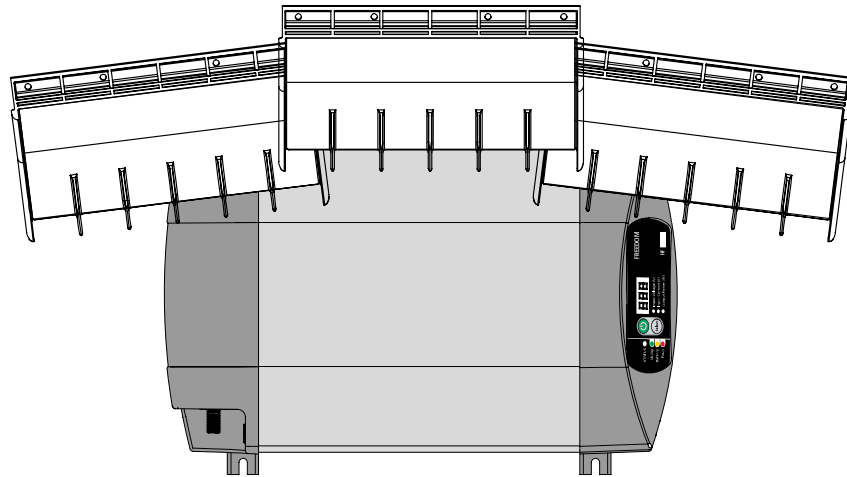

Figure 1-11 Typical Drip Shield Placement on a **Freedom HF 1800**

# 2 Configuration

Chapter 2 explains how to configure the **Freedom HF** to best meet your electrical system requirements.

It covers the following:

- Setting battery types on the main unit on [page 2-2](#).
- Adjusting display, alarm, and charging current settings on [page 2-3](#).

## Setting Battery Types on the Main Unit

You can attach different types of lead-acid batteries to the **Freedom HF**. Before installing batteries make sure that you configure the unit to optimize the charging process.



### **WARNING: Fire hazard**

Incorrectly setting the battery type can lead to battery damage and a risk of fire.

The settings can be changed by adjusting the dip switches found on the main unit behind the display panel.

Battery Type	Dip Switch Setting Switch 1 Switch 2	Bulk/Absorption	Float
Fixed	OFF OFF	13.5	13.5
Flooded	OFF ON (default)	14.4	13.5
GEL	ON OFF	14.2	13.8
AGM	ON ON	14.3	13.4

### **To adjust the battery type setting:**

By default the battery type is set to Flooded (OFF|ON) .

1. Detach the Display Panel to expose the Dip Switches.
2. Use the tip of your fingernail or a small screw driver with a flat tip to adjust the switches.

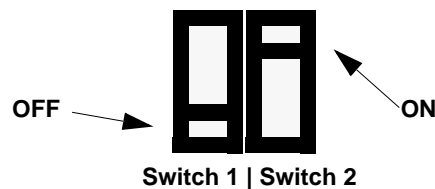

Figure 2-1 Dip Switches (Default Settings Shown)

## Adjusting Display, Alarm, and Charging Current Settings

The two display panel buttons can be used to adjust the following:

- What is being displayed on the screen,
- To disable or enable the audible alarm, and
- To change the charging current.

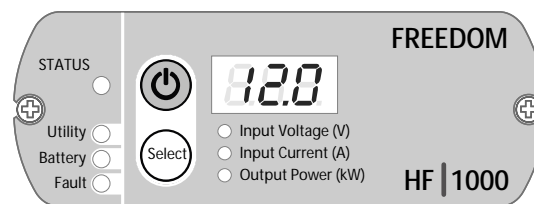

Figure 2-2 Display Panel

### To adjust what is being displayed on the screen:

By default the screen displays the Input Voltage value in Volts and the Input Voltage LED is illuminated.

1. Press the Select button once.  
The display will show the **DC Input Current** and the DC Input Current LED will illuminate.  
The value is displayed on the screen as Amps.
2. Press the Select button once again.  
The display will show the **AC Output Power** and the AC Output Power LED will illuminate.  
The value is displayed on the screen as kWatts.
3. Press the Select button once again.  
The display will show the **DC Input Voltage** and the DC Input Voltage LED will illuminate.  
The value is displayed on the screen as Volts.

---

**To adjust the alarm setting:**

By default the alarm is set to ON.

- Press and hold the Select button for two seconds.  
The display shows “**AL 0**” indicating that the alarm is OFF.  
The display shows “**AL 1**” indicating that the alarm is ON.

Whenever the alarm setting is changed, the display will temporarily show either “**AL 0**” or “**AL 1**” and after a few seconds will return to displaying what was on the screen prior to the adjustment.

---

**Note:** The alarm setting will reset to its default setting when the **Freedom HF**'s Inverter button is turned OFF then turned ON again.

---

**To adjust the charging current:**

By default the charging current is set to:

- 20A for the **Freedom HF 1000**
  - 40A for the **Freedom HF 1800**
1. Press and hold the Inverter button for five seconds.  
The unit will go into Charge Current Setting Mode.
  2. Press the Select button to toggle between the different Amp ratings.
    - **2 — 5 — 10 — 20** for the **Freedom HF 1000**
    - **2 — 10 — 20 — 40** for the **Freedom HF 1800**
  3. Choose the desired charging current by stopping at the value shown on the display. To maximize unit performance, see [Table 2-1 “Charging Current Guidelines”](#) below.  
Wait for five seconds and the charging current is set.

## Adjusting Display, Alarm, and Charging Current Settings

After the charging current is set, the display will return to displaying what was on the screen prior to the adjustment.

**Table 2-1** Charging Current Guidelines

AC Input Circuit Breaker or fuse size (Amps)	Charger DC Current Setting (Amps)		Maximum By-pass AC Current Available (Amps)	
	Freedom HF 1000	Freedom HF 1800	Freedom HF 1000	Freedom HF 1800
15	2	2	13.5	13.5
	5	10	12.5	11.0
	10	20	11.0	8.5
	20	40	8.5	3.5
20	2	2	18.5	18.5
	5	10	17.5	16
	10	20	16	13.5
	20	40	13.5	8.5
30	2	2	28.5	28.5
	5	10	27.5	26
	10	20	26	23.5
	20	40	23.5	18.5

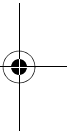
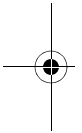
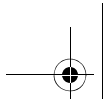

2-6

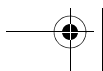
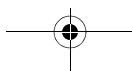



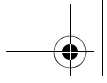

# A

## Specifications

[Appendix A](#) contains electrical performance information and product specifications.

---

**Important:** Specifications are subject to change without notice.

---

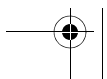
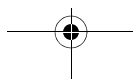
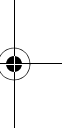
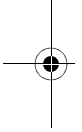

## Electrical Specifications: Inverter Mode

DC Input	Freedom HF 1000	Freedom HF 1800
Operating voltage range	10.5V–15.5V	10.5V–15.5V
Safe non-operating voltage range	0–16 Vdc	0–16 Vdc
Normal voltage	12.5V	12.5V
Nominal current at full load	100A	180A
AC Output	Freedom HF 1000	Freedom HF 1800
Output voltage	115 Vac	115 Vac
Continuous power	1.0kW @ 25 °C	1.8kW @ 25 °C
Surge power	17A (2kW for 200 ms)	30A (3.6kW for 300 ms)
Max short-circuit current	55A peak	55A peak
Frequency	60 Hz	60 Hz
Wave shape	Modified Sinewave	Modified Sinewave
Power derating above 40 °C ambient temp	See “ <a href="#">Invert Power Derating vs. Ambient Temperature</a> ” on page A–6.	
Peak efficiency	≥87%	≥87%
Full load efficiency	≥80%	≥80%
Other	Freedom HF 1000	Freedom HF 1800
No load input power (producing output voltage)	≤10W	≤10W
Off mode current draw	≤1mA	≤1mA

## Electrical Specifications: Charge Mode

AC Input	Freedom HF 1000	Freedom HF 1800
Operating voltage range	90–130 Vac	90–130 Vac
Nominal current	5Aac at 20A charge, 120 Vac in	10Aac at 40A charge, 120 Vac in
Nominal frequency	60 Hz	60 Hz
DC Output	Freedom HF 1000	Freedom HF 1800
Nominal voltage	12.0 Vdc	12.0 Vdc
Min battery voltage for charging	0.0 Vdc	0.0 Vdc
Max output voltage	14.4 Vdc	14.4 Vdc
Nominal output current	User selectable: 2A, 5A, 10A, 20A	User selectable: 2A, 10A, 20A, 40A
Charger current derating	Automatically reduce charger current as internal temperature exceeds 80 °C, and input Vac approaches low transfer.	
Efficiency at nominal output	≥75%	≥75%
Other	Freedom HF 1000	Freedom HF 1800
Battery type settings	Flooded (default), Gel, AGM, or Fixed (13.5V)	
Charge algorithms	Three stages (Bulk, Absorption, and Float)	
Independent battery banks	1	1

## Environmental Specifications

Ambient Temperature:	0–40 °C
Operating Temperature Range	-20–60 °C, with output derated above 25 °C
Storage Temperature Range	-40–70 °C
Humidity: Operation/Storage	5–95% RH, non-condensing

## System Specifications

Transfer relay rating	30A, 2.0hp
Transfer time	<30ms
Transfer on bad voltage	90–100V for low AC and 130–140 for high AC
Cooling	Fan, activated by any of the following: <ul style="list-style-type: none"> <li>• High internal temperature</li> <li>• High AC output power</li> </ul>

## Physical Specifications

Unit Dimensions and Weight	Freedom HF 1000	Freedom HF 1800
Length	15.5" (393mm)	18.0" (457mm)
Width	9.5" (241mm)	9.5" (241mm)
Height	4.2" (106mm)	4.2" (106mm)
Weight	10 lbs (4.5 kg)	12.8 lbs (5.8 kg)

## Regulatory Approvals

ETL approved to CSA 107.1, UL458, and UL458 Marine Supplement (drip shield with product number 808-9531 required).

## Inverter Overload Operation

This graph shows how long (measured in seconds) the **Freedom HF** will operate for a given output current (measured in Amps).

Both **Freedom HF 1000** and **Freedom HF 1800** are represented in the illustration below.

The graph illustrates inverter operation at 25 °C.

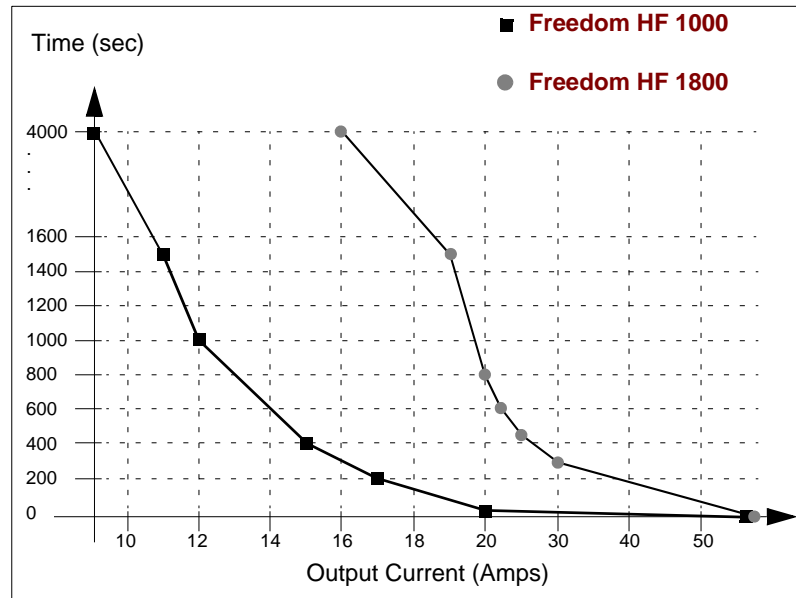

## Invert Power Derating vs. Ambient Temperature

If the unit is in inverter mode and in elevated ambient temperature above 25 °C, you will have to reduce power draw according to the following chart to avoid over-temperature shutdown.

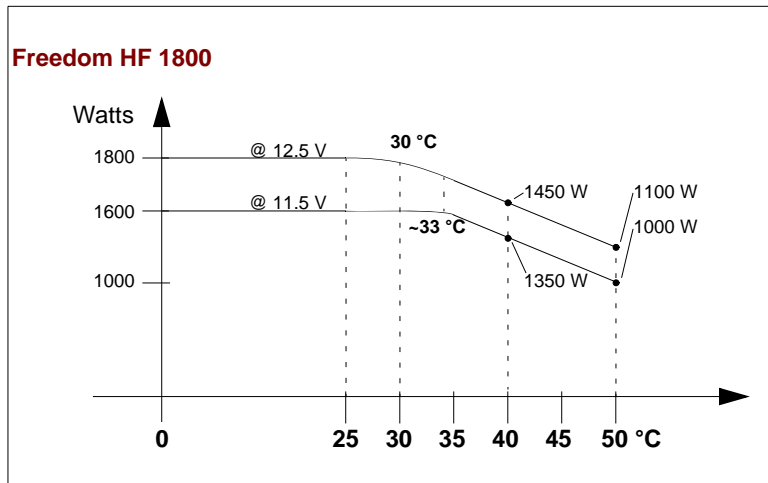
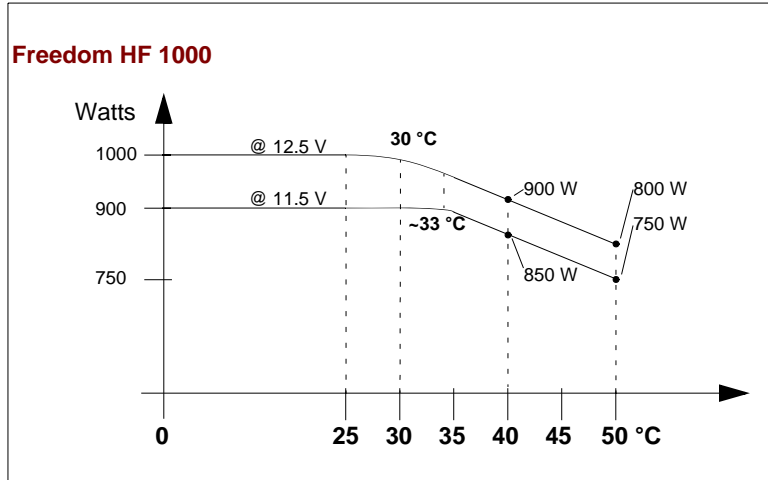

Charger Output Current vs. AC Input Voltage

## Charger Output Current vs. AC Input Voltage

When the **Freedom HF** is charging batteries from a weak shore power source the AC voltage may fall as the **Freedom HF** draws current. To reduce the chance of the shore power voltage collapsing below the configured transfer level the **Freedom HF** will reduce the charging current at low shore power voltage according to the following graph:

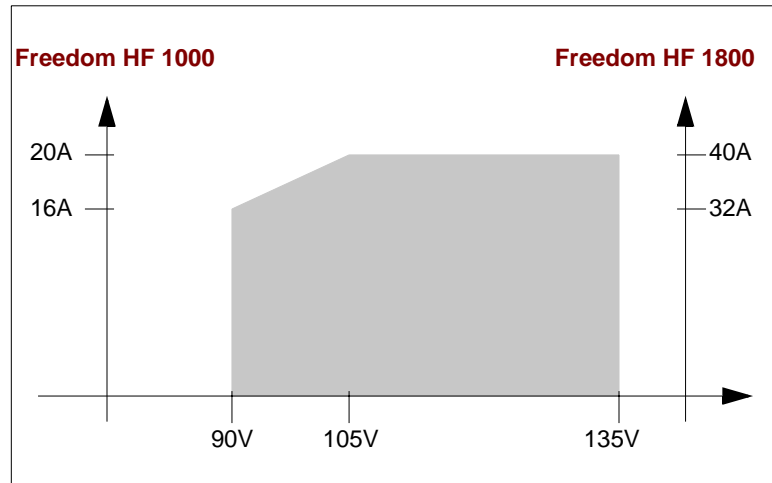
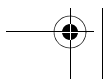
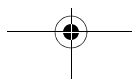
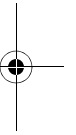
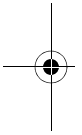
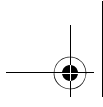
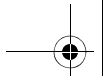

Table A-1 Charging Voltage

Battery Type	Bulk/Absorption (Volts)	Float (Volts)
Flooded	14.4	13.5
GEL	14.2	13.8
AGM	14.3	13.4
Fixed	13.5	13.5







# B

## Marine Installation Diagram

Appendix B illustrates a typical marine installation for the Freedom HF.

For a typical RV or Fleet installation, see Figure 1-2, “Typical Recreational Vehicle and Fleet Vehicle Installation” on page 1–6.

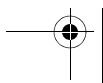
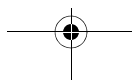
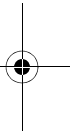
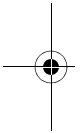

---

## Marine Installation

Figure B-1 illustrates a typical marine installation with the following components:

1. AC power supplied from a shore power connector
2. An AC source panel that includes a Max 30A circuit breaker that supplies the **Freedom HF**
3. An AC load panel with branch circuit breakers that supply only loads that run off the **Freedom HF**
4. Engine negative bus / DC ground bus
5. DC power supplied by a battery bank and protected by a DC fuse in the positive cable
6. Battery isolator
7. DC alternator
8. Starting battery
9. Drip shield (not shown)

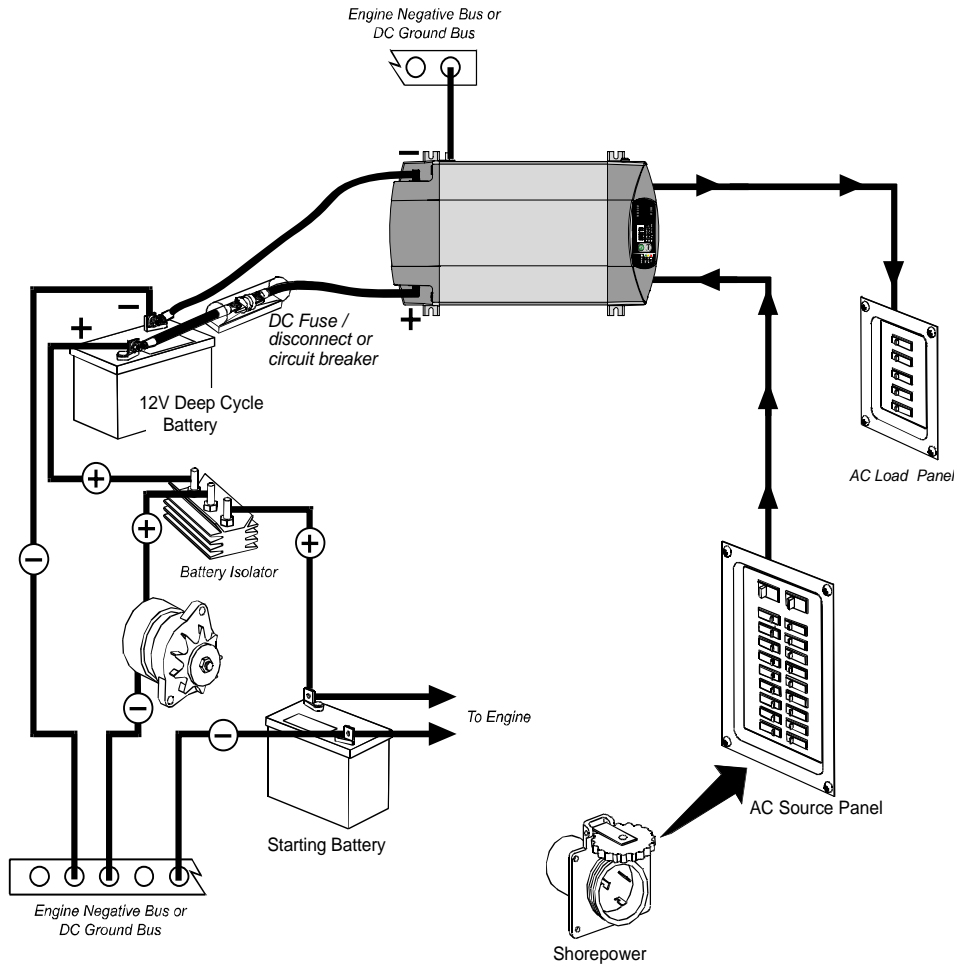
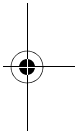
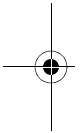
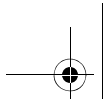
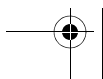
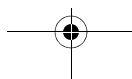
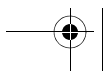
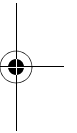
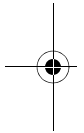
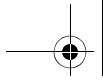

Figure B-1 Typical Marine Installation



B-4





<p><b>Xantrex Technology Inc.</b> 1 800 670 0707 Tel toll free NA 1 408 987 6030 Tel direct 1 800 994 7828 Fax toll free NA customerservice@xantrex.com www.xantrex.com</p> <p>975-0395-01-01</p>	<p>Printed in China</p>